

SKF Agri solutions

Achieve more with less



Contents

What our customers say about us	4	Seeding	38
Agri solutions overview		Application challenges	38
SKF Explorer range	6	Product tables by machine and position	
Application specific agricultural solutions	7	Disc opener	40
Bearing seals – range overview	8	Gauge wheel	42
Bearing seals – performance overview	10	Seedmeter and seedmeter drive shaft	43
Agri Hub range overview	11	Harvesting	44
Tractors	12	Application challenges – Combine harvester	44
Application challenges	12	Application challenges – Disc mower	45
Preferred assortment – Tapered roller bearings		Application challenges – Baling	45
Tapered roller bearings – metric range	13	Product tables by machine and position	
Tapered roller bearings – inch range	17	Combine harvester – Head	46
Tapered roller bearings – matched	18	Combine harvester – Feederhouse/Rotor	47
Preferred assortment – Seals		Combine harvester – Clean Grain/Residue	48
Seals – metric range	19	Disc mower – Gear and shaft drive	52
Seals – inch range	21	Baling – Pick-up	53
Application specific offers		Baling – Round baler	54
Tapered roller bearings	25	Baling – Square baler	56
SKF Mudblock seals	25	Attachments and trailer wheels	58
Tillage	26	Application challenges	58
Application challenges – Primary tillage	26	Product tables by machine and position	
Application challenges – Secondary tillage	27	Implement wheel and walking beam	59
Product tables by machine and position			
Primary tillage – Disc plough	28		
Secondary tillage – Independent tillage disc	29		
Secondary tillage – Gang disc	32		
Secondary tillage – Seedbed finisher	35		

SKF, together with its brand PEER, provides solutions and products for equipment in all stages of the crop cycle.

With a full standard assortment from SKF and complementary, customer-specific solutions from PEER, you can achieve high reliability, at low ownership and operating costs. You can get global availability and a best-in-class bearing logistic network, enabling you to acquire any spare part and have it shipped to wherever you are located.

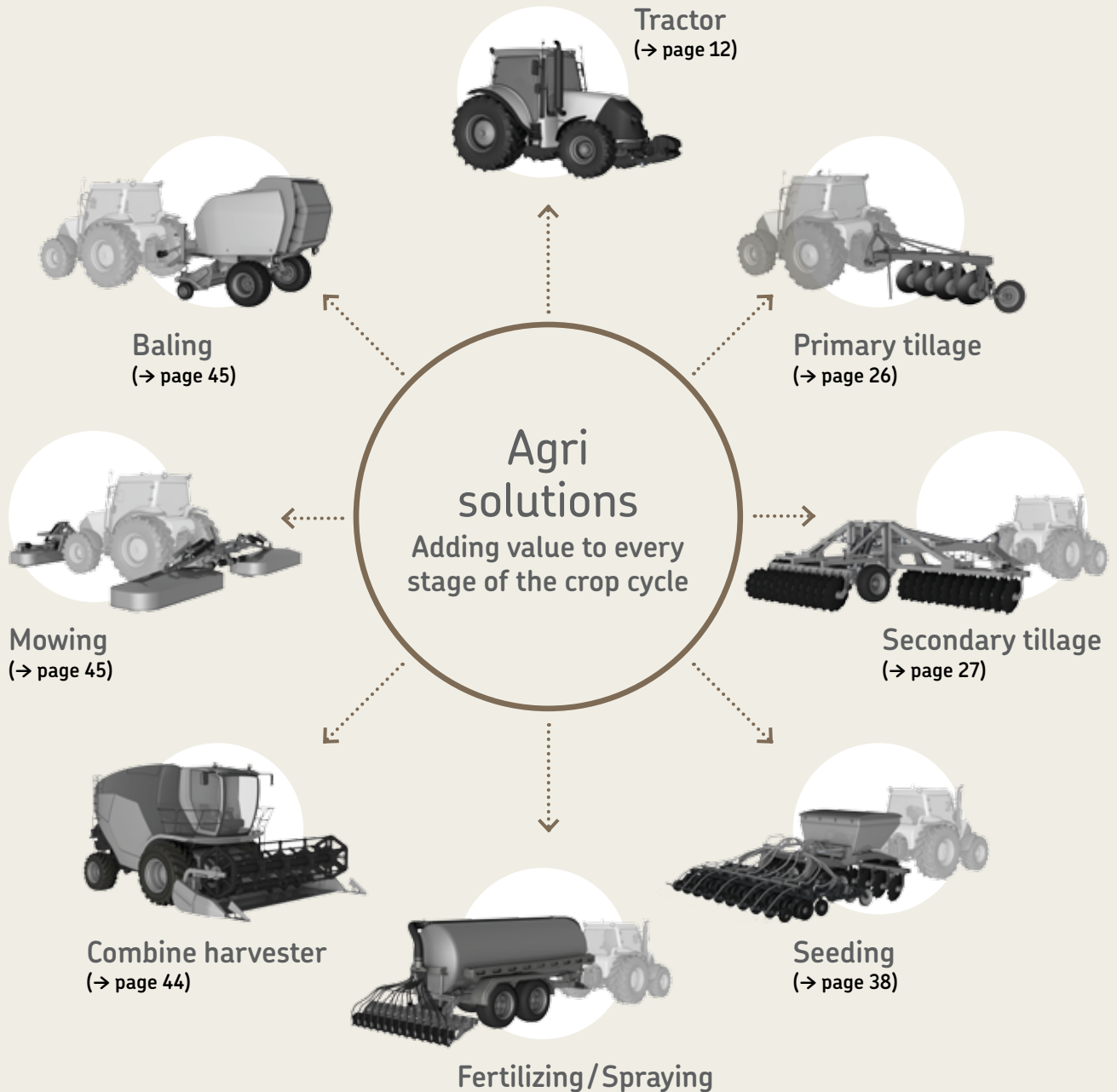

What our customers say about us

Agri hubs and units for tillage



“My farm requires 40 days tillage a year – 30 in spring to prepare for the maize and 10 in autumn to prepare for the wheat. With the SKF Agri Hub there is no need to wash and lubricate the discs and I save half an hour a day. The work is done more quickly and easily. We drive at more than 20 km/h and I have seen an improvement in the way the land is worked: with the old harrow the top speed was 7 or 8 km/h. The old 2.5 metre harrow worked one hectare an hour, the new machine, which is still 2.5 metres covers two and half hectares an hour. The old 20 disc harrow required a 20 kilo can of grease each year. With this new solution, I’ve eliminated greasing and washing. In my job I’m in contact with nature every day and I’m pleased that with the SKF solution I’m not polluting the land with grease anymore.”

During testing:
“We’ve pulled our Norwood Kwik-Till machine 11–12 mph through the field and so far have covered 8 000 acres with zero bearing failures. That is truly exceptional!”

Dan Norwood
President, Norwood Sales Inc., USA

“After one season in Russia, the PEER gang disc unit performs more than two times better than the previous grease relube solution.”

Luca Rigon
Engineering Manager Tillage Equipment,
Maschio Gaspardo

“The PEER bearing unit passed two tillage seasons in the rolling basket application without any failures and performed way better than the previous solution.”

Cyril Thirouin
Engineering Director, Gregoire Besson,
Rabe, Agriway

Cooperation

“The machines are becoming more and more complicated so we have to improve the material that we use and systems that make these machines easy to use for the operators, otherwise it is difficult to be successful. Normally, in the past years, the suppliers were giving us just components. But, today they have to work with us to identify and supply complete systems to integrate into our machines and develop together with our engineers to be more and more interesting for the market. So we need strong cooperation with experts and suppliers to solve the problems of each single system.

In this case, SKF can help us to complete our machines with high-quality and cost effective solutions.”

Gianfranco Donadon
Technical director, R&D,
Maschio Gaspardo

“We are constantly looking to customer needs. For those customer needs, we go to engineering who help us develop new products that cope with these requirements. Customers don't like downtime, and maintenance is a kind of downtime. So they try to reduce that as much as possible. That's why we want suppliers like SKF, who will reduce our customers' downtime.”

Marcel Verhoeven
Combine Harvester Product Manager,
New Holland

“We have been designing and building corn harvesting machines for over sixty years. Customers are looking for increasingly advanced machines able to improve production in less time and with higher quality. Olimac has focused most of its resources on technological research and innovation. This has enabled us to design and produce corn heads allowing for complete corn harvesting of every ear and kernel without any product loss. We buy bearings from SKF because SKF bearings are of high quality and high precision, superior to other suppliers. They contribute to long life and great performance in our products.”

Lorenzo Carboni
Research & Development Director,
Olimac s.r.l.

Bearings for harvesting, seeding and tillage

“SKF insert bearings are premium products that deliver premium performance. That's why we chose them in the first place, and why we don't ever intend to switch.”

Javier López
C.E.O.,
Industrias David, Spain

“We have seen a significant change in quality – for the better. Now we can harvest a whole season without replacing any bearings. It saves a lot of time when we are able to harvest without any downtime through the whole season. The 3-lip insert bearings have given us more reliability and savings in man-hours. I warmly recommend them.”

Ole Madsen
Owner of Kjargaarden farm
SKF bearings were purchased via Kramp
Denmark.

“The relubrication-free units supplied by PEER Bearing offer significantly improved bearing life over traditional bearings.”

Ben Covell
Product Development Manager,
Simba Great Plains

SKF Explorer range

Recommended for tractors



SKF Explorer rolling bearings accommodate higher load levels and provide extended service life.

Optimized internal geometry reduces friction, wear and heat generation, allowing heavier loads to be accommodated.

Their advanced surface finish reduces friction and enhances lubricating conditions.

Diagram 1

SKF Explorer design

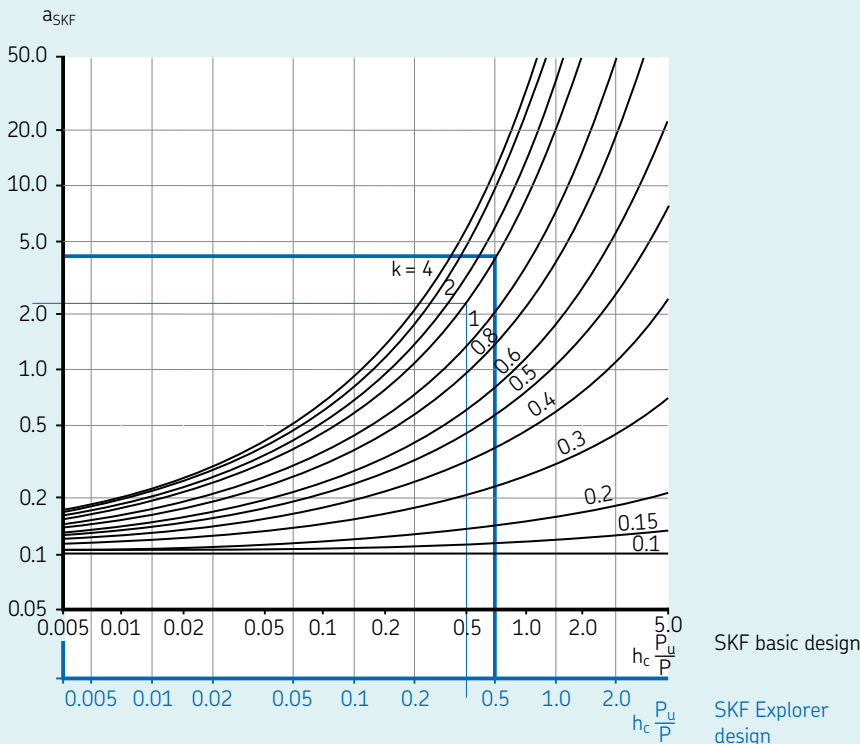

* The factor a_{SKF} represents the relationship between the fatigue load limit ratio (P_u/P), the lubrication condition (viscosity ratio k) and the contamination level in the bearing (h_c).

Example: SKF Explorer tapered roller bearings – get more uptime all the time

- Robustness
- Wear resistance
- Reliable in operation
- Long service intervals
- Contamination resistance
- Additional options include case hardened bearings and coatings

- Double service life of application under tough conditions
- Up to 23% increased dynamic load ratings

Application specific agricultural solutions

Recommended for agricultural attachments

Proven through years of research, development and rigorous testing in both the lab and field, the advanced sealing technology can significantly increase performance for the customer.

The application specific agricultural products offer a high-performance solution designed to reduce the need for relubrication, saving precious hours needed for field work. The seal design can provide significantly improved contamination exclusion than the conventional triple-lip seal design.

Application specific engineered assemblies can offer higher reliability, are relubrication-free and can simplify the installation. As an environmental friendly solution, grease purge to contaminate the soil can be avoided.



Diagram 2

Reduced total cost of ownership for farmers

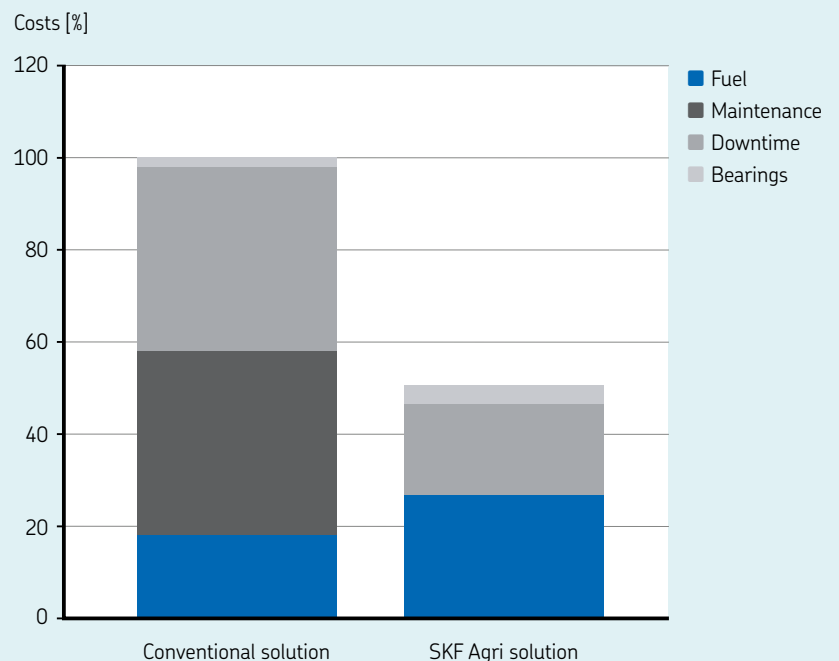





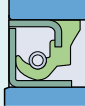
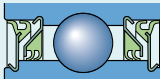
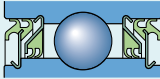
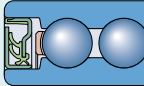

All figures and graphs are rounded off and based on SKF testing estimates.

Bearing seals – range overview

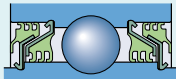
Seal type	Abbreviation in product tables	Seal cross section	Application max. speed (r/min)
Single lip	1-lip R 1-lip RST		4 000
Single lip	1-lip RS1		4 000
Single lip	1-lip RSH		4 000
Single lip with flinger	1-lip 2F		4 000
Single lip	1-lip F		4 000
Single lip	1-lip G		4 000
Single lip with rubberized flinger	1-lip RF		2 000
2-lip	2-lip		2 000
3-lip high speed	3-lip HS		1 000
3-lip low speed	3-lip LS		600

According to application and typical environment, recommended seal design differs. Our application engineers help you and develop new product and seal designs before mud slurry testing and field tests can validate the product.

Seal type	Abbreviation in product tables	Seal cross section	Application max. speed (r/min)
Cassette seal	CS		3 500
4-lip	4-lip		400
5-lip	5-lip		400
SKF Mudblock for seeding	MS		400
6-lip	6-lip		300
7-lip	7-lip		300
Double cassette seal	DS		300
SKF Mudblock	MB		300
SKF Mudblock + Cassette seal	MC		300

Bearing seals – performance overview

Diagram 3

Seal performance in mudslurry test

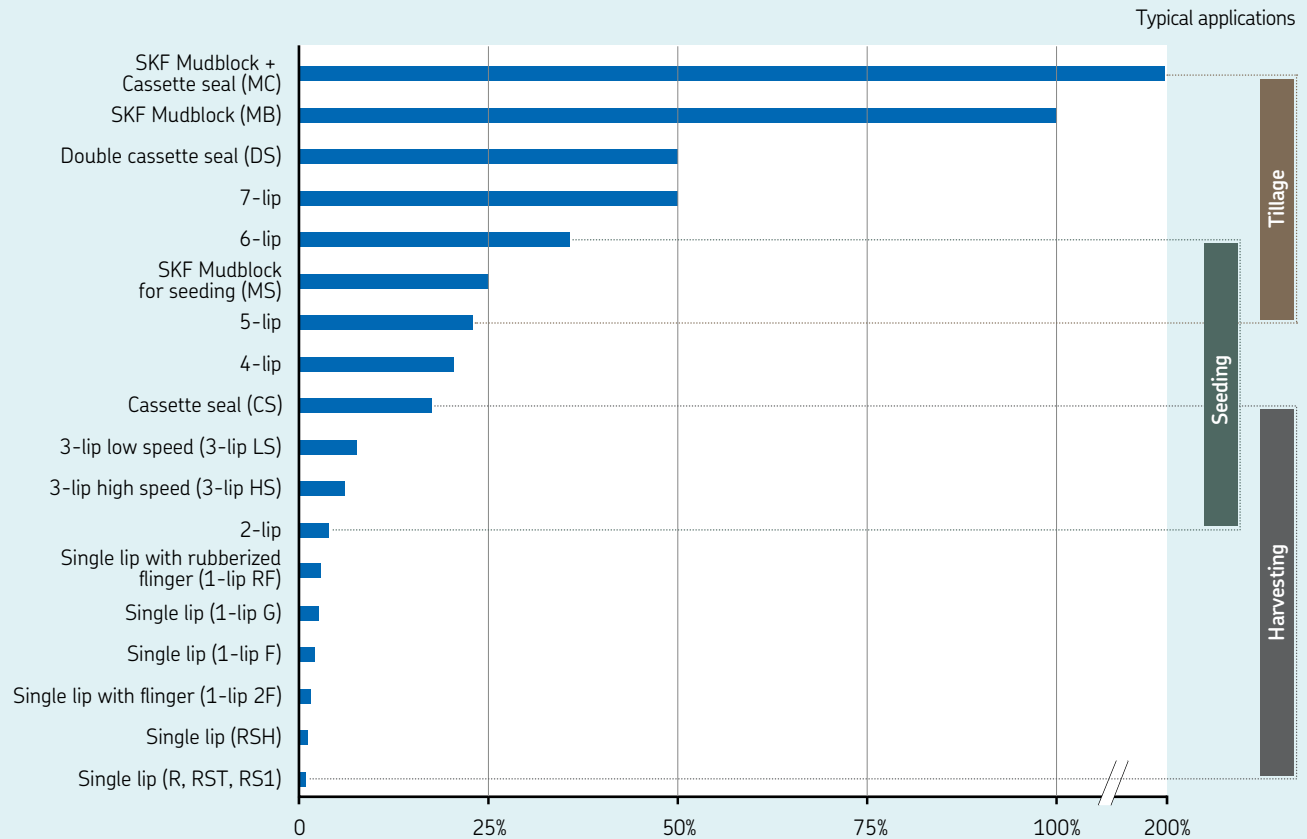

All figures and graphs are rounded off and based on SKF testing estimates. Source: Lab test and customer field experience since 1997



Mudslurry test rig

Agri Hub range overview

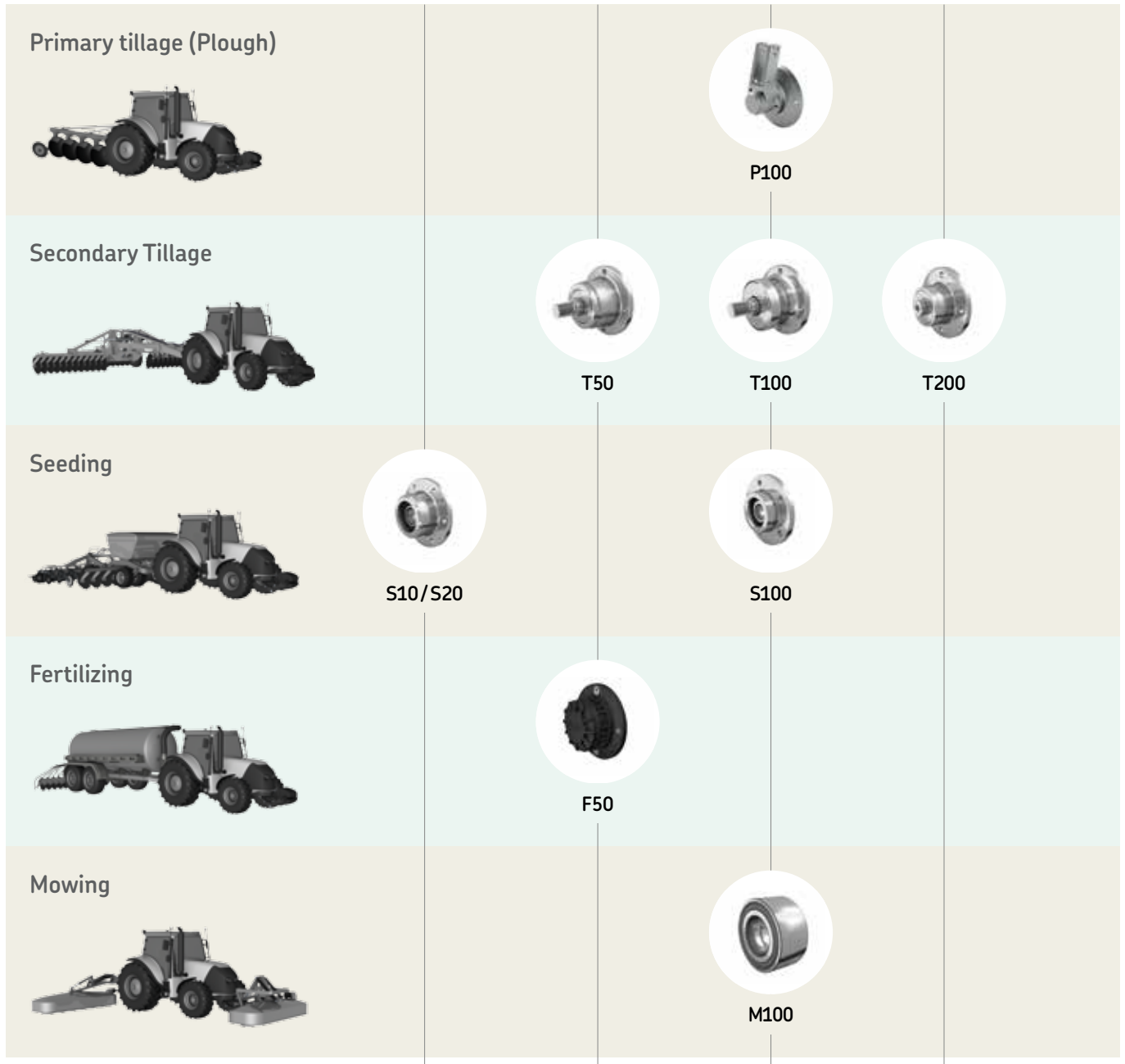

Optimal conditions	hectares	10 000	50 000	100 000	200 000
	acres	25 000	120 000	250 000	500 000
Heavy conditions (harsh, abrasive, wet and muddy)	hectares	1 000	5 000	10 000	20 000
	acres	2 500	12 000	25 000	50 000

All figures and graphs are rounded off and based on optimal conditions, acc. to SKF testing estimates.

Tractors

Agricultural tractors are the work horses of the industry with drivetrain, engine, suspension and steering being key sub-systems. Safety, availability and productivity are the underlying forces driving many of the industry trends, such as:

- Automation, smart functionality and power management
- Better efficiency which reduces frictional losses, resulting in lower fuel costs
- Increased power density and reliability
- Standardization (consolidation of the powertrain)
- Improved comfort and safety



Application challenges

On-road time and travelling between locations means time away from the field. Allowing higher on-road speeds whilst maintaining a compact tractor design with tighter turning circles can increase the portion of time that these assets are truly productive. Additional challenges are:

- Long, intensive work periods
- Exposure to the elements and harsh ground conditions
- Reducing grease consumption
- Increasing productivity, efficiency and profitability

If key components are not designed for these kinds of conditions, it can easily lead to damage and early life failure. Such events lower productivity, increase maintenance costs and reduce overall profitability.

Solutions for tractors

Among the many products especially developed to handle harsh conditions, SKF offers a wide range of SKF Explorer roller and ball bearings, plain bearings and bushings, geared hub units and seals.

For steering and suspension, reliance on grease lubrication increases the maintenance costs and also risks both crop contamination and disruption to the sensors that are increasingly a part of the digitalization of farming.



Designation	Dimensions			Basic load ratings		Fatigue load ratings	Speed ratings	
	Inner diameter	Outer diameter	Overall width	dynamic	static		Reference speed	Limiting speed
	d	D	B	C	C ₀	P _u		
–	mm			kN		kN	r/min	
32005 X	25	47	15,00	33,2	32,5	3,25	12 000	14 000
30205	25	52	16,25	38,1	33,5	3,45	11 000	13 000
32205 B	25	52	19,25	44,5	44,0	4,65	10 000	13 000
33205	25	52	22,00	57,9	56,0	6,00	10 000	13 000
30305	25	62	18,25	55,3	43,0	4,75	9 500	12 000
31305	25	62	18,25	46,6	40,0	4,40	8 500	11 000
32305	25	62	25,25	74,1	63,0	7,10	9 000	12 000
320/28 X	28	52	16,00	39,0	38,0	4,00	10 000	13 000
322/28 B	28	58	20,25	51,9	50,0	5,50	9 500	12 000
302/28	28	58	17,25	46,6	41,5	4,40	10 000	12 000
32006 X	30	55	17,00	43,9	44,0	4,55	10 000	12 000
30206	30	62	17,25	50,0	44,0	4,80	9 000	11 000
32206	30	62	21,25	61,8	57,0	6,30	9 000	11 000
33206	30	62	25,00	79,7	76,5	8,50	8 500	11 000
30306	30	72	20,75	69,2	56,0	6,40	8 000	10 000
31306	30	72	20,75	58,3	50,0	5,70	7 500	9 500
32306	30	72	28,75	95,0	85,0	9,65	7 500	10 000
320/32 X	32	58	17,00	45,1	46,5	4,80	9 000	11 000
32007 X	35	62	18,00	52,3	54,0	5,85	8 500	10 000
30207	35	72	18,25	63,2	56,0	6,10	8 000	9 500
32207	35	72	24,25	81,2	78,0	8,50	8 000	9 500
33207	35	72	28,00	104,0	106,0	11,80	7 000	9 500
30307	35	80	22,75	88,9	73,5	8,30	7 500	9 000
31307	35	80	22,75	75,4	67,0	7,80	6 300	8 500
32307	35	80	32,75	117,0	106,0	12,20	6 700	9 000
32307 B	35	80	32,75	115,0	114,0	12,90	6 300	8 500
32008 X	40	68	19,00	64,7	71,0	7,65	7 500	9 500
30208	40	80	19,75	75,8	68,0	7,65	7 000	8 500
32208	40	80	24,75	91,6	86,5	9,80	7 000	8 500
33208	40	80	32,00	128,0	132,0	15,00	6 300	8 500
30308	40	90	25,25	106,0	95,0	10,80	6 300	8 000
32308	40	90	35,25	143,0	140,0	16,00	6 000	8 000
33108	40	75	26,00	97,5	104,0	11,40	7 000	9 000
32009 X	45	75	20,00	71,7	80,0	8,80	7 000	8 500
33109	45	80	26,00	104,0	114,0	12,90	6 700	8 000
30209	45	85	20,75	81,6	76,5	8,65	6 300	8 000



Designation	Dimensions			Basic load ratings		Fatigue load ratings	Speed ratings	
	Inner diameter	Outer diameter	Overall width	dynamic	static		Reference speed	Limiting speed
	d	D	B	C	C ₀	P _u		
–	mm			kN		kN	r/min	
33209	45	85	32,00	132,0	143,0	16,30	6 000	7 500
30309	45	100	27,25	132,0	120,0	14,30	5 600	7 000
32309	45	100	38,25	173,0	170,0	20,40	5 300	7 000
T2ED 045	45	95	36,00	182,0	186,0	20,80	6 000	7 000
32209	45	85	24,75	98,7	98,0	11,00	6 300	8 000
32010 X	50	80	20,00	75,1	88,0	9,65	6 300	8 000
33010	50	80	24,00	84,8	102,0	11,40	6 300	8 000
30210	50	90	21,75	93,1	91,5	10,40	6 000	7 500
32210	50	90	24,75	101,0	100,0	11,40	6 000	7 500
33210	50	90	32,00	142,0	160,0	18,30	5 300	7 000
30310	50	110	29,25	154,0	140,0	16,60	5 300	6 300
32310	50	110	42,25	211,0	212,0	24,00	4 800	6 300
T2ED 050	50	100	36,00	189,0	200,0	22,40	5 600	6 700
33110	50	85	26,00	106,0	122,0	13,40	6 000	7 500
32011 X	55	90	23,00	99,4	116,0	12,90	5 600	7 000
33111	55	95	30,00	136,0	156,0	17,60	5 600	6 700
30211	55	100	22,75	111,0	106,0	12,00	5 300	6 700
32211	55	100	26,75	130,0	129,0	15,00	5 300	6 700
33211	55	100	35,00	170,0	190,0	21,60	4 800	6 300
30311	55	120	31,50	176,0	163,0	19,30	4 800	5 600
31311	55	120	31,50	149,0	137,0	16,60	4 300	5 600
32311	55	120	45,50	245,0	250,0	28,50	4 300	5 600
33011	55	90	27,00	111,0	137,0	15,30	5 600	7 000
32911	55	80	17,00	51,7	69,5	7,20	6 300	7 500
30212	60	110	23,75	120,0	114,0	13,20	5 000	6 000
32212	60	110	29,75	155,0	160,0	18,60	5 000	6 000
33212	60	110	38,00	207,0	236,0	26,50	4 500	6 000
30312	60	130	33,50	208,0	196,0	23,60	4 300	5 300
31312	60	130	33,50	177,0	166,0	20,40	3 800	5 300
32312	60	130	48,50	282,0	290,0	34,00	4 000	5 300
T2EE 060	60	115	40,00	239,0	260,0	30,00	4 800	5 600
33012	60	95	27,00	113,0	143,0	16,00	5 300	6 700
33112	60	100	30,00	144,0	170,0	19,60	5 300	6 300
32013 X	65	100	23,00	103,0	127,0	14,00	5 000	6 000
33013	65	100	27,00	119,0	153,0	17,30	5 000	6 300
30213	65	120	24,75	141,0	134,0	16,30	4 500	5 600



Designation	Dimensions			Basic load ratings		Fatigue load ratings	Speed ratings	
	Inner diameter	Outer diameter	Overall width	dynamic	static		Reference speed	Limiting speed
	d	D	B	C	C ₀	P _u		
–	mm			kN		kN	r/min	
32213	85	180	44,50	186,0	193,0	22,80	4 500	5 600
33213	85	180	63,50	239,0	270,0	30,50	4 000	5 300
30313	90	140	32,00	240,0	228,0	27,50	4 000	4 800
32313	90	140	39,00	323,0	335,0	40,00	3 600	4 800
T2DD 065	90	160	32,50	170,0	193,0	22,40	4 800	6 000
32014 X	90	160	42,50	125,0	153,0	17,30	4 500	5 600
33014	90	190	46,50	159,0	196,0	22,80	4 800	5 600
33114	90	190	46,50	211,0	250,0	28,50	4 300	5 300
30214	90	190	67,50	155,0	156,0	18,00	4 300	5 300
32214	90	160	55,00	195,0	208,0	24,50	4 300	5 300
33214	90	150	45,00	247,0	285,0	32,50	3 800	5 000
30314	95	145	32,00	271,0	260,0	31,00	3 800	4 500
32314	95	145	39,00	363,0	380,0	45,00	3 400	4 500
32015 X	95	170	34,50	130,0	163,0	18,60	4 300	5 300
33015	95	200	71,50	167,0	228,0	26,00	4 300	5 300
33115	95	170	58,00	216,0	265,0	30,00	4 000	5 000
30215	95	170	45,50	171,0	176,0	20,40	4 000	5 000
32215	95	200	49,50	197,0	212,0	24,50	4 000	5 000
33215	100	150	39,00	255,0	300,0	34,00	3 600	4 800
30315	100	180	37,00	301,0	290,0	34,00	3 400	4 300
32315	100	180	49,00	416,0	440,0	51,00	3 200	4 300
32016 X	100	215	51,50	168,0	216,0	24,50	4 000	5 000
33016	100	215	77,50	207,0	285,0	32,00	4 000	5 000
33116	100	145	24,00	221,0	280,0	31,00	4 000	4 800
30216	100	140	25,00	184,0	183,0	21,20	3 800	4 800
32216	100	215	56,50	228,0	245,0	28,50	3 800	4 500
33216	80	140	46,00	308,0	375,0	41,50	3 400	4 500
30316	80	170	42,50	333,0	320,0	36,50	3 200	4 000
32316	80	170	61,50	404,0	500,0	56,00	3 000	4 000
32017 X	85	130	29,00	171,0	224,0	25,50	3 800	4 800
33017	85	130	36,00	223,0	310,0	34,50	3 800	4 800
33117	85	140	41,00	268,0	340,0	38,00	3 600	4 500
30217	85	150	30,50	216,0	220,0	25,50	3 600	4 300
32217	85	150	38,50	263,0	285,0	33,50	3 600	4 300
33217	85	150	49,00	353,0	430,0	48,00	3 200	4 300
30317	85	180	44,50	372,0	365,0	40,50	3 000	3 800



Designation	Dimensions			Basic load ratings		Fatigue load ratings	Speed ratings	
	Inner diameter	Outer diameter	Overall width	dynamic	static		Reference speed	Limiting speed
	d	D	B	C	C ₀	P _u		
–	mm			kN		kN	r/min	
31317	85	180	44,50	297,0	285,0	32,00	2 800	3 800
32317	85	180	63,50	435,0	530,0	60,00	2 800	3 800
32018 X	90	140	32,00	208,0	270,0	31,00	3 600	4 300
33018	90	140	39,00	266,0	355,0	39,00	3 600	4 500
30218	90	160	32,50	240,0	245,0	28,50	3 400	4 000
32218	90	160	42,50	309,0	340,0	38,00	3 400	4 000
30318	90	190	46,50	353,0	400,0	44,00	2 600	3 600
31318	90	190	46,50	283,0	315,0	35,50	2 400	3 400
32318	90	190	67,50	487,0	610,0	65,50	2 600	3 600
33218	90	160	55,00	415,0	520,0	57,00	3 000	4 000
33118	90	150	45,00	310,0	390,0	43,00	3 400	4 300
32019 X	95	145	32,00	206,0	270,0	30,50	3 400	4 300
33019	95	145	39,00	272,0	375,0	40,50	3 400	4 300
30219	95	170	34,50	266,0	275,0	31,50	3 200	3 800
32319	95	200	71,50	535,0	670,0	72,00	2 400	3 400
33219	95	170	58,00	460,0	560,0	62,00	2 800	3 800
32219	95	170	45,50	348,0	390,0	43,00	3 200	3 800
31319	95	200	49,50	314,0	355,0	39,00	2 400	3 400
33020	100	150	39,00	278,0	390,0	41,50	3 400	4 000
30220	100	180	37,00	304,0	320,0	36,00	3 000	3 600
32220	100	180	49,00	390,0	440,0	48,00	3 000	3 600
30320	100	215	51,50	431,0	490,0	53,00	2 400	3 200
32320	100	215	77,50	617,0	780,0	83,00	2 200	3 200
T4CB 100	100	145	24,00	154,0	190,0	20,80	3 400	4 300
32920	100	140	25,00	147,0	204,0	22,40	3 400	4 300
31320 X	100	215	56,50	399,0	465,0	51,00	2 200	3 000



Designation	Dimensions			Basic load ratings		Fatigue load ratings	Speed ratings	
	Inner diameter	Outer diameter	Overall width	dynamic	static		Reference speed	Limiting speed
	d	D	B	C	C ₀	P _u		
–	mm			kN		kN	r/min	
L 44643/610	25,400	50,292	14,224	32,0	30,0	3,00	11 000	13 000
L 44649/610	26,988	50,292	14,224	32,0	30,0	3,00	11 000	13 000
L 45449/410	29,000	50,292	14,224	31,8	32,5	3,35	11 000	13 000
15123/15245	31,750	62,000	18,161	59,5	57,0	6,20	9 000	11 000
LM 48548 A/510	34,925	65,088	18,034	58,0	57,0	6,20	8 500	10 000
L 68149/111	34,987	59,975	15,875	40,6	44,0	4,50	9 000	11 000
L 68149/110	34,987	59,131	15,875	40,6	44,0	4,50	9 000	11 000
LM 29748/710	38,100	65,088	18,034	53,0	57,0	6,10	8 000	10 000
LM 29749/710	38,100	65,088	18,034	53,0	57,0	6,10	8 000	10 000
HM 801346/310	38,100	82,550	29,370	106,0	118,0	13,40	6 700	8 000
25572/25520	38,100	82,931	23,812	99,1	106,0	11,80	6 700	8 000
16150/16284	38,100	72,238	20,638	60,3	60,0	6,55	8 000	9 500
LM 300849/811	41,000	68,000	17,500	53,6	58,5	6,30	8 000	9 500
LM 501349/310	41,275	73,431	19,558	67,6	68,0	7,65	7 500	9 000
LM 501349/314	41,275	73,431	21,430	67,6	68,0	7,65	7 500	9 000
24780/24720	41,275	76,200	22,225	84,2	86,5	9,65	7 000	9 000
18590/18520	41,275	73,025	16,667	57,7	56,0	6,20	7 500	9 000
25577/25520	42,875	82,931	23,812	99,1	106,0	11,80	6 700	8 000
535/532 A	44,450	111,125	38,100	183,0	190,0	21,60	5 300	6 300
535/532 X	44,450	107,950	36,512	183,0	190,0	21,60	5 300	6 300
53178/53377	44,450	95,250	30,958	108,0	96,5	11,40	5 300	7 000
LM 102949/910	45,242	73,431	19,558	66,0	75,0	8,15	7 000	8 500
LM 503349/310	46,000	75,000	18,000	62,1	71,0	7,65	7 000	8 500
18690/18620	46,038	79,375	17,462	61,1	62,0	6,80	7 000	8 500
537/532 X	50,800	107,950	36,512	183,0	190,0	21,60	5 300	6 300
4580/4535	50,800	104,775	39,688	195,0	224,0	25,00	5 300	6 300
539/532 X	53,975	107,950	36,512	183,0	190,0	21,60	5 300	6 300
539/532 A	53,975	111,125	38,100	183,0	190,0	21,60	5 300	6 300
462/453 X	57,150	104,775	30,162	150,0	160,0	18,60	5 300	6 300
39581/39520	57,150	112,712	30,162	175,0	204,0	23,60	4 500	5 600
29675/29620	69,850	112,712	25,400	121,0	156,0	17,60	4 500	5 300
47487/47420	69,850	120,000	32,545	188,0	228,0	26,50	4 300	5 300
47487/47420 A	69,850	120,000	32,545	188,0	228,0	26,50	4 300	5 300
42687/42620	76,200	127,000	30,162	171,0	204,0	24,00	4 000	5 000
L 814749/710	76,200	109,538	19,050	72,1	102,0	11,00	4 500	5 600
42690/42620	77,788	127,000	30,163	171,0	204,0	24,00	4 000	5 000
HM 220149/110	100,000	157,000	42,000	303,0	400,0	42,50	3 200	4 000



Designation	Dimensions			Basic load ratings		Fatigue load ratings	Speed ratings	
	Inner diameter	Outer diameter	Overall width	dynamic	static		Reference speed	Limiting speed
	d	D	B	C	C ₀	P _u		
–	mm			kN		kN	r/min	
31318/DF	90	190	89,5	486,0	630,0	71,0	1 900	3 400
31318/DFC70	90	190	89,5	486,0	630,0	71,0	1 900	3 400
32219/DF	95	170	88,5	597,0	780,0	86,5	2 600	3 800
31319/DF	95	200	94,5	539,0	710,0	78,0	1 800	3 400
31319/DFC190	95	200	94,5	539,0	710,0	78,0	1 800	3 400
30220/DF	100	180	71,0	521,0	640,0	72,0	2 400	3 600
31320 X/DF	100	215	107,5	685,0	930,0	102,0	1 700	3 000
32220/DF	100	180	95,0	668,0	880,0	96,5	2 400	3 600



CRW1 R



CRW1 NBT



HMS5 RG

HMSA10 RG
HMSA10 RG1

Designation	Dimensions			Material code	Auxiliary lip A = contacting	Speed ratings	
	Inner diameter	Outer diameter	Overall width			m/s	ft/min
	d	D	B				
–	mm					m/s	ft/min
12x22x7 CRW1 R	12	22	7	NBR	–	18	3 600
14x24x7 HMSA10 RG	14	24	7	NBR	A	14	2 755
15x35x7 HMSA10 RG	15	35	7	NBR	A	14	2 755
15x24x7 HMSA10 RG1 ¹⁾	15	24	7	NBR	A	14	2 755
17x35x7 CRW1 R	17	35	7	NBR	–	18	3 600
17x40x7 HMSA10 RG	17	40	7	NBR	A	14	2 755
20x40x7 HMSA10 RG	20	40	7	NBR	A	14	2 755
20x30x7 HMSA10 RG	20	30	7	NBR	A	14	2 755
20x35x7 HMSA10 RG	20	35	7	NBR	A	14	2 755
20x35x7 HMS5 RG	20	35	7	NBR	–	14	2 755
20x47x7 HMSA10 RG	20	47	7	NBR	A	14	2 755
25x47x7 HMS5 RG	25	47	7	NBR	–	14	2 755
25x47x7 HMSA10 RG	25	47	7	NBR	A	14	2 755
25x52x7 HMSA10 RG	25	52	7	NBR	A	14	2 755
25x40x7 HMSA10 RG	25	40	7	NBR	A	14	2 755
25x35x7 HMSA10 RG	25	35	7	NBR	A	14	2 755
25x38x7 HMSA10 RG	25	38	7	NBR	A	14	2 755
25x37x7 HMSA10 RG	25	37	7	NBR	A	14	2 755
25x35x7 HMS5 RG	25	35	7	NBR	–	14	2 755
30x47x7 CRW1 R	30	47	7	NBR	–	18	3 600
30x45x8 CRW1 R	30	45	8	NBR	–	18	3 600
30x47x7 HMSA10 RG	30	47	7	NBR	A	14	2 755
30x40x7 HMS5 RG	30	40	7	NBR	–	14	2 755
30x52x7 HMSA10 RG	30	52	7	NBR	A	14	2 755
30x40x7 HMSA10 RG	30	40	7	NBR	A	14	2 755
30x62x7 HMSA10 RG	30	62	7	NBR	A	14	2 755
35x47x7 HMSA10 RG	35	47	7	NBR	A	14	2 755
35x47x7 HMS5 RG	35	47	7	NBR	–	14	2 755
35x52x7 HMS5 RG	35	52	7	NBR	–	14	2 755
35x52x7 HMSA10 RG	35	52	7	NBR	A	14	2 755
35x62x7 HMS5 RG	35	62	7	NBR	–	14	2 755
35x72x8 CRW1 R	35	72	8	NBR	–	18	3 600
35x72x10 HMSA10 RG	35	72	10	NBR	A	14	2 755
35x55x10 HMSA10 RG	35	55	10	NBR	A	14	2 755
35x58x10 HMSA10 RG	35	58	10	NBR	A	14	2 755
38x52x7 HMSA10 RG	38	52	7	NBR	A	14	2 755

¹⁾ Seal of same size and design that differ in execution from the basic design are identified by a number e.g. R1



Designation	Dimensions			Material code	Auxiliary lip A = contacting	Speed ratings	
	Inner diameter	Outer diameter	Overall width			m/s	ft/min
	d	D	B				
	mm					m/s	ft/min
40x62x7 HMSA10 RG	40	62	7	NBR	A	14	2 755
40x52x7 HMSA10 RG	40	52	7	NBR	A	14	2 755
40x80x10 HMSA10 RG	40	80	10	NBR	A	14	2 755
40x55x7 HMS5 RG	40	55	7	NBR	–	14	2 755
45x62x7 HMSA10 V	45	62	7	FKM	A	14	2 755
45x72x8 HMS5 RG	45	72	8	NBR	–	14	2 755
45x62x10 HMSA10 RG	45	62	10	NBR	A	14	2 755
45x75x8 HMSA10 RG	45	75	8	NBR	A	14	2 755
45x65x8 HMSA10 RG	45	65	8	NBR	A	14	2 755
45x72x8 HMSA10 RG	45	72	8	NBR	A	14	2 755
45x65x8 HMS5 RG	45	65	8	NBR	–	14	2 755
46x68x8 CRW1 R	46	68	8	NBR	–	18	3 600
50x68x8 CRW1 R	50	68	8	NBR	–	18	3 600
50x80x10 HMSA10 RG	50	80	10	NBR	A	14	2 755
50x72x8 HMSA10 RG	50	72	8	NBR	A	14	2 755
50x80x8 HMSA10 RG	50	80	8	NBR	A	14	2 755
55x72x8 HMSA10 RG	55	72	8	NBR	A	14	2 755
55x80x8 HMSA10 RG	55	80	8	NBR	A	14	2 755
60x80x10 HMS5 RG	60	80	10	NBR	–	14	2 755
60x75x8 HMS5 RG	60	75	8	NBR	–	14	2 755
63x90x10 HMSA10 RG	63	90	10	NBR	A	14	2 755
65x85x10 HMSA10 RG	65	85	10	NBR	A	14	2 755
65x100x10 HMSA10 RG	65	100	10	NBR	A	14	2 755
70x90x10 HMSA10 RG	70	90	10	NBR	A	14	2 755
70x85x8 HMSA10 RG	70	85	8	NBR	A	14	2 755
75x95x10 HMSA10 RG	75	95	10	NBR	A	14	2 755
75x100x10 HMS5 RG	75	100	10	NBR	–	14	2 755



CRW1 R



CRW1 V



CRWA1 R



CRWA1 V



CRWA5 R

Designation	Design	Dimensions			Material code	Auxiliary lip A = contacting	Speed ratings	
		Inner diameter d	Outer diameter D	Overall width B			m/s	ft/min
–		mm						
4985	CRWA1 R	12,70	25,37	6,35	NBR	A	18	3 600
6904	CRWA1 R	15,88	28,55	6,35	NBR	A	18	3 600
6373	CRWA1 R	15,88	34,93	6,35	NBR	A	18	3 600
6229	CRWA5 R	15,88	28,55	9,53	NBR	A	10	2 000
7443	CRWA1 R	19,05	31,75	6,50	NBR	A	18	3 600
7513	CRWA1 R	19,05	34,93	6,35	NBR	A	18	3 600
7512	CRW1 R	19,05	34,93	6,35	NBR	–	18	3 600
8624	CRW1 R	22,23	31,75	4,78	NBR	–	18	3 600
8648	CRW1 R	22,23	34,93	6,50	NBR	–	18	3 600
8660	CRWA5 R	22,23	34,93	6,35	NBR	A	10	2 000
8700	CRW1 R	22,23	38,07	6,35	NBR	–	18	3 600
9878	CRWA1 R	25,40	38,07	6,35	NBR	A	18	3 600
9837	CRW1 R	25,40	36,50	6,35	NBR	–	18	3 600
9998	CRWA1 R	25,40	44,50	6,35	NBR	A	18	3 600
9833	CRW1 V	25,40	36,50	6,35	FKM	–	18	3 600
9935	CRWA1 R	25,40	41,25	6,35	NBR	A	18	3 600
10124	CRWA1 R	25,40	50,80	6,35	NBR	A	18	3 600
9876	CRW1 R	25,40	38,07	6,35	NBR	–	18	3 600
9843	CRWA5 R	25,40	38,07	6,35	NBR	A	10	2 000
10114	CRWA1 R	25,40	50,37	7,95	NBR	A	18	3 600
9934	CRW1 R	25,40	41,25	6,35	NBR	–	18	3 600
10740	CRW1 R	27,00	50,80	6,35	NBR	–	18	3 600
10681	CRW1 R	27,00	46,43	6,35	NBR	–	18	3 600
11067	CRW1 R	28,58	39,65	6,50	NBR	–	18	3 600
11223	CRWA1 R	28,58	47,60	6,35	NBR	A	18	3 600
11124	CRWA1 R	28,58	41,25	6,50	NBR	A	18	3 600
11123	CRW1 R	28,58	41,25	6,35	NBR	–	18	3 600
12614	CRWA1 R	31,75	60,30	7,95	NBR	A	18	3 600
12427	CRW1 R	31,75	50,37	6,35	NBR	–	18	3 600
12383	CRWA1 V	31,75	47,60	6,35	FKM	A	18	3 600
12428	CRWA1 R	31,75	50,37	6,35	NBR	A	18	3 600
12363	CRW1 R	31,75	44,50	6,35	NBR	–	18	3 600
12456	CRW1 R	31,75	50,80	6,35	NBR	–	18	3 600
12458	CRWA1 R	31,75	50,80	6,35	NBR	A	18	3 600
12350	CRWA1 R	31,75	42,85	7,95	NBR	A	18	3 600
12364	CRWA1 R	31,75	44,50	6,35	NBR	A	18	3 600

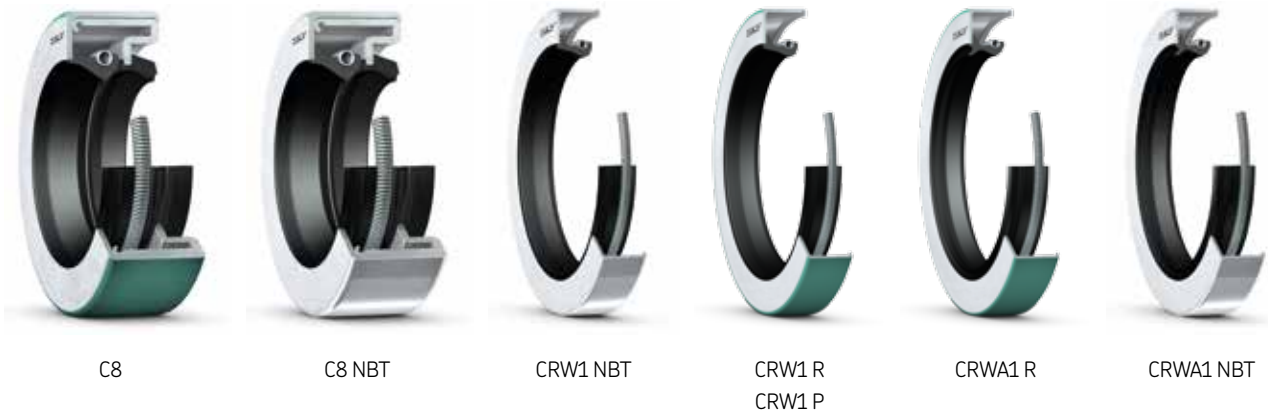

Designation	Design	Dimensions			Material code	Auxiliary lip A = contacting	Speed ratings	
		Inner diameter d	Outer diameter D	Overall width B			m/s	ft/min
		mm						
12577	CRW1 R	31,75	57,15	6,35	NBR	–	18	3 600
13569	CRWA1 R	34,93	50,80	7,95	NBR	A	18	3 600
13651	CRWA1 R	34,93	53,98	7,95	NBR	A	18	3 600
13649	CRW1 R	34,93	53,98	7,95	NBR	–	18	3 600
13534	CRW1 R	34,93	47,60	6,50	NBR	–	18	3 600
13535	CRWA1 R	34,93	47,60	7,95	NBR	A	18	3 600
13865	CRW1 R	34,93	63,55	7,95	NBR	–	18	3 600
14939	CRWA1 R	38,10	57,15	7,95	NBR	A	18	3 600
15005	CRWA1 R	38,10	60,30	7,95	NBR	A	18	3 600
14938	CRW1 R	38,10	57,15	7,95	NBR	–	18	3 600
14855	CRW1 R	38,10	50,80	7,95	NBR	–	18	3 600
15176	CRW1 R	38,10	65,05	7,95	NBR	–	18	3 600
15093	CRWA1 R	38,10	62,00	7,95	NBR	A	18	3 600
14832	CRW1 R	38,10	50,37	7,95	NBR	–	18	3 600
14807	CRW1 NBT	38,10	47,60	6,35	NBR	–	18	3 600
15142	CRWA1 R	38,10	63,55	7,95	NBR	A	18	3 600
15517	CRW1 NBT	39,70	53,98	7,95	NBR	–	18	3 600
15707	CRW1 R	39,70	68,22	7,95	NBR	–	18	3 600
16062	CRWA1 R	41,28	57,10	7,95	NBR	A	18	3 600
16128	CRWA1 R	41,28	61,90	7,95	NBR	A	18	3 600
16314	CRW1 R	41,28	66,62	7,95	NBR	–	18	3 600
16085	CRWA1 R	41,28	60,30	7,95	NBR	A	18	3 600
16364	CRW1 R	41,28	69,85	6,35	NBR	–	18	3 600
16900	CRW1 NBT	42,88	69,85	7,95	NBR	–	18	3 600
17271	CRWA1 R	44,45	60,30	7,95	NBR	A	18	3 600
17443	CRWA1 R	44,45	66,62	7,95	NBR	A	18	3 600
17285	CRWA1 R	44,45	61,90	8,00	NBR	A	18	3 600
17607	CRWA1 R	44,45	69,00	11,13	NBR	A	18	3 600
17386	CRW1 R	44,45	63,55	7,95	NBR	–	18	3 600
17653	CRW1 R	44,45	73,03	7,95	NBR	–	18	3 600
17231	CRW1 R	44,45	57,15	7,95	NBR	–	18	3 600
17404	CRW1 R	44,45	65,05	7,95	NBR	–	18	3 600
17387	CRWA1 R	44,45	63,55	7,95	NBR	A	18	3 600
17557	CRW1 R	44,45	69,85	7,95	NBR	–	18	3 600
17523	CRWA1 R	44,45	69,85	7,95	NBR	A	18	3 600
18671	CRW1 R	47,63	70,05	7,95	ACM	–	18	3 600



Designation	Design	Dimensions			Material code	Auxiliary lip A = contacting	Speed ratings	
		Inner diameter d	Outer diameter D	Overall width B			m/s	ft/min
		mm						
18581	CRWA1 R	47,63	66,62	7,95	NBR	A	18	3 600
18565	CRW1 R	47,63	63,55	7,95	NBR	–	18	3 600
18562	CRW1 P	47,63	65,07	7,95	ACM	–	18	3 600
19227	CRWA1 V	49,23	66,62	7,95	FKM	A	18	3 600
19229	CRWA1 R	49,23	66,62	7,95	NBR	A	18	3 600
19359	CRW1 R	49,23	76,20	7,95	NBR	–	18	3 600
19380	CRW1 R	49,23	77,75	7,95	NBR	–	18	3 600
19360	CRWA1 NBT	49,23	76,20	7,95	NBR	A	18	3 600
19745	CRW1 P	50,80	63,55	7,95	ACM	–	18	3 600
19969	CRWH1 R	50,80	76,12	9,53	NBR	–	18	3 600
19979	CRWH1 V	50,80	76,12	9,53	FKM	–	18	3 600
19762	CRWA1 R	50,80	66,62	7,95	NBR	A	18	3 600
19786	CRWA1 R	50,80	68,99	9,53	NBR	A	18	3 600
19832	CRWA1 R	50,80	69,85	7,95	NBR	A	18	3 600
19876	C8 NBT	50,80	73,00	17,86	NBR	–	–	–
21352	CRWA1 R	53,98	85,62	9,53	NBR	A	18	3 600
22400	CRWA1 R	57,15	79,38	9,53	NBR	A	18	3 600
22493	CRWHA1 R	57,15	85,09	11,13	NBR	A	18	3 600
22532	CRWHA1 R	57,15	85,62	11,13	NBR	A	18	3 600
22354	CRWA1 R	57,15	76,20	9,53	NBR	A	18	3 600
22558	CRWH1 R	57,15	85,62	11,13	NBR	–	18	3 600
23061	CRW1 R	58,75	79,38	9,53	NBR	–	18	3 600
23184	CRW1 NBT	58,75	88,90	7,95	NBR	–	18	3 600
25091	CRWH1 NBT	63,50	95,28	11,13	NBR	–	18	3 600
24988	CRWHA1 R	63,50	88,90	11,13	NBR	A	18	3 600
25102	CRWHA1 P	63,50	98,45	11,91	ACM	A	18	3 600
24898	CRWA1 R	63,50	82,58	9,53	NBR	A	18	3 600
24899	CRWA1 V	63,50	82,58	9,53	FKM	A	18	3 600
27362	CRWA1 R	69,85	95,28	11,13	NBR	A	18	3 600
27269	CRWA1 R	69,85	88,90	9,53	NBR	A	18	3 600
27368	CRWH1 R	69,85	95,28	11,13	NBR	–	18	3 600
27370	CRWHA1 R	69,85	95,28	11,13	NBR	A	18	3 600
27625	CRWHA1 R	69,85	110,00	12,70	NBR	A	18	3 600
27565	CRWHA1 NBT	69,85	101,68	11,13	ACM	A	18	3 600
28790	C8	73,03	101,68	19,05	NBR	–	–	–
29224	CRWA1 R	74,63	95,28	9,53	NBR	A	18	3 600



CRW1 R



CRWA1 R



CRWH1 R



CRWHA1 R

Designation	Design	Dimensions			Material code	Auxiliary lip A = contacting	Speed ratings	
		Inner diameter d	Outer diameter D	Overall width B			m/s	ft/min
–		mm						
30087	CRWH1 R	76,20	114,30	11,13	NBR	–	18	3 600
30095	CRWHA1 R	76,20	114,30	11,13	NBR	A	18	3 600
29906	CRW1 R	76,20	101,68	9,53	NBR	–	18	3 600
29907	CRWA1 R	76,20	101,68	9,53	NBR	A	18	3 600
33772	CRWH1 R	85,73	117,50	11,13	NBR	–	18	3 600
33701	CRWA1 R	85,73	111,15	9,53	NBR	A	18	3 600
43771	CRWH1 R	111,13	152,43	12,70	NBR	–	18	3 600
52488	CRWH1 R	133,35	165,10	12,70	NBR	–	18	3 600



Tapered roller bearing



SKF Mudblock

Designation	Dimensions			Basic load ratings		Fatigue load ratings	Speed ratings		
	Inner diameter	Outer diameter	Overall width	dynamic	static		r/min		
–	d	D	B	C	C ₀	P _u			
–	mm			kN		kN			
Driven front wheel end – Tapered roller bearing									
JL819349-JL819310	95,000	135,00	20,00	82,9	147	17,9	2 739	3 721	
37431A-37625	109,538	158,75	23,02	106,0	174	21,2	2 530	3 365	
JP12049A-10-T4	120,000	170,00	27,00	170,0	266	32,4	2 329	3 349	
JP13049AXT-10-T4	130,000	185,00	29,00	193,0	305	37,2	2 194	3 165	
JP14049/10-TX-E	140,000	195,00	34,92	190,0	305	37,2	2 395	3 300	
Wheel end – SKF Mudblock									
70x95x14/15 MUD11 R ¹⁾	95,000	70,00	15/16	–	–	–	150	300	
90x120x15/16 MUD11 R ¹⁾	120,000	90,00	15/16	–	–	–	150	300	
130x160x15/16 MUD11 R ¹⁾	160,000	130,00	15/16	–	–	–	150	300	
133.46x183x15/16 MUD11 R ¹⁾	183,000	133,46	15/16	–	–	–	150	300	
140x170x15/16 MUD11 R ¹⁾	170,000	140,00	15/16	–	–	–	150	300	
145x175x15/16 MUD11 R ¹⁾	175,000	145,00	15/16	–	–	–	150	300	
150x180x15/16 MUD11 R ¹⁾	180,000	150,00	15/16	–	–	–	150	300	
158.75x200x15/16 MUD11 R ¹⁾	200,000	158,75	15/16	–	–	–	150	300	
165x190x15/16 MUD11 R ¹⁾	190,000	165,00	15/16	–	–	–	150	300	
170x200x15/16 MUD11 R ¹⁾	200,000	170,00	15/16	–	–	–	150	300	
190x220x16/18 MUD11 R ¹⁾	220,000	190,00	16/18	–	–	–	150	300	
210x240x16/18 MUD11 R ¹⁾	240,000	210,00	16/18	–	–	–	150	300	

¹⁾ Tolerance d=H8, Tolerance D=h8

Tillage

Tillage is the first step of the agriculture process and typically is carried out twice per year, in spring and autumn. The purpose is to prepare the soil for new seed. This means turning nutritious soil to the surface and integrating crop residues to a lower layer of the soil to facilitate decay. Another important purpose for tillage is to break up the soil so that it will achieve the right balance of moisture and air to avoid soil erosion. This is done by using tillage discs to cut through the soil and seedbed finishers to then level and firm.

The potential gains for a farmer using the right components for tillage equipment can be significant: increased productivity by up to 150%, reduced cost of ownership by up to 30% and easier installation and repair.

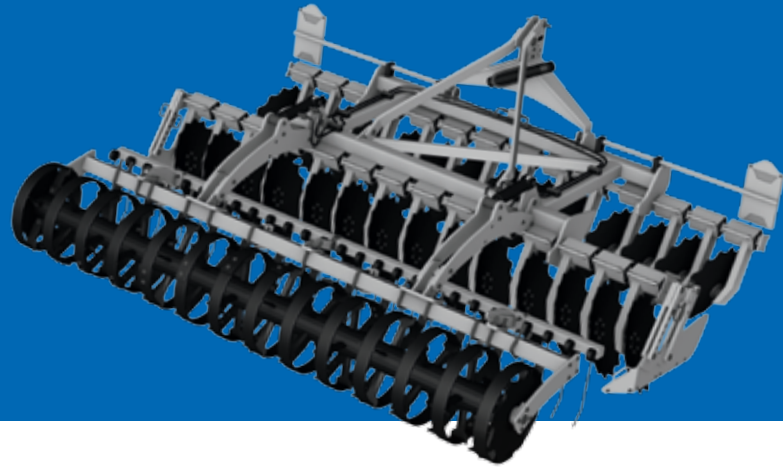

Application challenges

- Very harsh environment: mud, water, dust and crop residues
- Tilting forces, shock loads and stone impacts
- Higher machine speeds (for higher productivity)
- Avoiding tillage machine downtime during the season

If the tillage bearings are not customized and prepared for these kinds of conditions, it can easily lead to damage and early life failure. This is especially true if the seal fails or if a re-lubricated bearing is not regularly re-greased. Such events lower the productivity, increase maintenance costs and reduce overall profitability. It can also impact the precision and thus, the quality of the farmer's work.

Primary tillage



Disc plough

Typical conditions for disc plough applications

The initial major soil working operation designed to plough the soil deeply to reduce soil strength, cover plant materials and rearrange aggregates is called primary tillage.

The main implement used for primary tillage is a plough. Ploughing essentially consists of opening the upper crust of the soil, breaking the clods and making the soil suitable for sowing seeds.

One plough machine is the disc plough. Disc plough cuts, turns and in some cases breaks furrow slices by means of separately mounted large steel concave discs. A disc plough is designed to reduce friction by making a rolling plough bottom instead of sliding plough bottom as in the case of mouldboard plough. A disc plough works well where mouldboard ploughs do not work satisfactorily.

Application challenges

- Very harsh environment: mud, water, dust and crop residues
- High Tilting forces, shock loads and stone impacts
- Avoiding disc plough machine downtime during the season

SKF Agri Hub Disc Plough

SKF designed and developed a ready to mount and dismount SKF Agri Hub Disc Plough.

Benefits

- OEMs
 - Simplified supply chain
 - Assembly cost
- End-users
 - Reduced downtime
 - Increased service life during season
 - Relubrication-free

Secondary tillage



Independent tillage disc

Typical conditions for independent disc applications

- Disc speed: 90–350 r/min
- Tractor speed: up to 20 km/h

Solutions for independent disc applications

Among the many products especially developed to handle harsh conditions for independent disc applications, SKF offers both bearings and complete hub units. One of the most robust solutions is the SKF Agri Hub, consisting of angular contact ball bearings which are greased and sealed for-life, a cassette seal, stub shaft for the arm interface and flange for disc mounting. The integrated nature of the hub facilitates mounting and prolongs its service life to maximize the yield and the availability of agricultural machines.

Benefits of SKF Agri Hub for tillage

- OEMs
 - Cost-effective solution
 - Higher product quality and reliability
 - Supports sustainability efforts
 - Reduces assembly times
- End-users
 - Increased farm productivity and profitability
 - Relubrication-free
 - Environmentally friendly
 - Easy to install/replace



Gang disc

Typical conditions for gang disc applications

- Tractor speed up to 12 km/h
- Utilizes two to three support bearings on a common shaft with several discs spaced with spools
- Constant and unpredictable movement of the gang shaft can generate severe stress on the internal components of the support bearings
- A great working depth places the bearings directly into the flow of soil and crop residue

Solutions for gang disc applications

One of the most commonly used gang disc bearing arrangements is the trunnion housing.

Benefits and functional features of PEER Tillage Trunnion Unit (TTU)

- Bolt-on performance
 - Directly interchangeable industry standard units
 - Static misalignment capability can accommodate imprecise mounting surfaces
- Increased productivity and bearing life in field
 - Dynamic misalignment capability can reduce internal bearing damage
 - Shock load protection due to high grade ductile iron housing
 - Patented sealing system can avoid the need for relubrication

Seedbed finisher for independent tillage disc and gang disc

Typical conditions for seedbed finisher applications

- Two bearing units, one at each end of the finisher.
- Operates closely/directly in soil.
- Subject to high misalignment forces
 - statically due to imprecise mounting surfaces, and
 - dynamically due to the wide bearing span and attachment deflections.

Solutions for seedbed finisher applications

The bearing arrangements best suited to seedbed finisher applications are SKF flanged insert bearing units. They come in a variety of designs with both square flange and oval flange. Common to all insert bearing solutions for agriculture applications though is that they are relubrication-free with a five-lip seal to withstand the tough operating conditions.

Benefits of insert bearing units

- OEMs
 - Differentiated designs
 - Reduced warranty, engineering, testing and assembly costs
- End-users
 - Extend service life up to 30% to 50% when fitted with five-lip seal
 - Increase farm productivity
 - Reduce maintenance and ownership costs
 - Reduce environmental impact

¹⁾ Based on SKF testing against conventional bearings. Savings and results will vary in specific applications.



Agri Hub P100
Type 1

Designation	Type	Bore/shaft diameter	Housing material	Pitch diameter	Seal type	Performance	Disc diameter
–		mm	–	mm	–	–	mm
Disc – Agri Hub AGPU 40236X4N-MC/001	1	40	Ductile cast iron	236,22	MC	P100	up to 710



Agri Hub T50
Type 1



Agri Hub T50
Type 2



Agri Hub T100
Type 3



Agri Hub T100/T200
Type 4

Designation	Type	Bore/shaft diameter	Housing material	Pitch diameter	Holes	Seal type	Performance	Disc diameter
–		mm	–	mm	–	–	–	mm

Independent tillage disc – Agri Hub

AGHU2898X4E-DSC	1	28	Steel	98,0	4	DS	T50	up to 610
AGHU2898X4E-DSCS	1	28	Steel	98,0	4	DS	T50	up to 610
AGHU2898X5E-DSCS	1	28	Steel	98,0	5	DS	T50	up to 610
AGHU2898X6E-DSCS	1	28	Steel	98,0	6	DS	T50	up to 610
AGHU2890X5E-DSC	1	28	Steel	90,0	5	DS	T50	up to 610
HUB-30MM	2	30	Steel	98,0	4	7-lip	T50	up to 550
HUB-30MM-ASSY-A528	2	30	Steel	101,6	4	7-lip	T50	up to 550
HUB-30MM-X-ASSY-A549	2	30	Steel	127,0	4	7-lip	T50	up to 550
HUB-30MM-X-ASSY-A561	2	30	Steel	98,0	4	7-lip	T50	up to 550
HUB-30MM-X-ASSY-A603	2	30	Steel	107,9	4	7-lip	T50	up to 550
HUB-30MM-X-ASSY-A615	2	30	Steel	98,0	4	7-lip	T50	up to 550
HUB-30MM-X-ASSY-A626	2	30	Steel	98,0	4	7-lip	T50	up to 550
BAA-0003	3	30	Steel	98,0	4	MB	T100	up to 610
BAA-0003 A	3	30	Steel	98,0	4	MB	T100	up to 610
BAA-0004	4	30	Steel	98,0	4	MB	T100	up to 610
BAA-0005	4	30	Steel	98,0	4	MB	T100	up to 610
BAA-0006	4	30	Steel	98,0	6	MB	T100	up to 610
BAA-0012	4	30	Steel	98,0	5	MB	T100	up to 610
BAA-0013	4	30	Steel	98,0	4	MB	T100	up to 610
BAA-0023 ¹⁾	4	30	Steel	98,0	4	MB	T100	up to 610
BAA-0045	4	30	Steel	98,0	4	MC	T200	up to 610

¹⁾ Zinc coated end shaft



Agri Hub T50
Type 2



Agri Hub T200
Type 6

Designation	Type	Bore/shaft diameter	Housing material	Pitch diameter	Holes	Seal type	Performance	Disc diameter
–		mm	–	mm	–	–	–	mm
Independent tillage disc – Agri Hub								
HUB-35MM	2	35	Steel	112,0	5	6-lip	T50	up to 610
HUB-35MM-ASSY-A519	2	35	Steel	112,0	5	6-lip	T50	600-650
HUB-35MM-X-ASSY-A243	2	35	Steel	150,0	6	7-lip	T50	600-650
HUB-35MM-X-ASSY-A601	2	35	Steel	150,0	6	7-lip	T50	600-650
BAA-0026	6	39	Steel	133,3	4	MC	T200	up to 750
BAA-0037	6	39	Steel	133,3	4	MC	T200	up to 750
HUB-40MM-ASSY	2	40	Steel	140,0	5	6-lip	T50	up to 700
HUB-40MM-ASSY-A554	2	40	Steel	180,0	6	6-lip	T50	up to 700
HUB-40MM-X-ASSY-A436	2	40	Steel	140,0	5	7-lip	T50	up to 700
HUB-40MM-X-ASSY-A438	2	40	Steel	122,0	6	7-lip	T50	up to 700
HUB-40MM-X-ASSY-A439	2	40	Steel	133,3	4	7-lip	T50	up to 700
HUB-40MM-X-ASSY-A548	2	40	Steel	102,0	4	7-lip	T50	up to 700
HUB-40MM-X-ASSY-A575	2	40	Steel	133,4	4	7-lip	T50	up to 700
HUB-40MM-X-ASSY-A591	2	40	Steel	140,0	5	7-lip	T50	up to 700
HUB-40MM-X-ASSY-A614	2	40	Steel	113,0	5	7-lip	T50	up to 700
HUB-40MM-X-ASSY-A628	2	40	Steel	130,0	6	7-lip	T50	up to 700



Angular contact ball bearing
Type 1



Hub bearing unit (HBU1)
Type 2



Hub bearing unit (HBU1T)
Type 3

Designation	Type	Bore/shaft diameter	Bore type	Outer diameter	Seal type
–		mm	–	mm	–
Independent tillage disc – Angular contact ball bearings					
3206 CETN9	1	30	Round	62	1-lip RS1
3206 CE-2RSH1TN9	1	30	Round	62	1-lip RS1
3206 CE-2RS1TN9	1	30	Round	62	1-lip RS1
3306 CETN9	1	30	Round	72	1-lip RS1
3306 CE-2RSH1TN9	1	30	Round	72	1-lip RS1
3306 CE-2RS1TN9	1	30	Round	72	1-lip RS1
3207 CETN9	1	35	Round	72	1-lip RS1
3207 CE-2RSH1TN9	1	35	Round	72	1-lip RS1
3207 CE-2RS1TN9	1	35	Round	72	1-lip RS1
3307 CETN9	1	35	Round	80	1-lip RS1
3307 CE-2RSH1TN9	1	35	Round	80	1-lip RS1
3307 CE-2RS1TN9	1	35	Round	80	1-lip RS1
Independent tillage disc – Hub bearing unit					
BAHB 636187 C	2	40	Round	80	CS
BTH-1024 AE	3	40	Round	74	CS



Relubricatable bearings with square bore
Type 1



Relubricatable bearings with round bore
Type 2

Designation	Type	Bore/shaft diameter	Bore type	Outer diameter	Seal type
–		mm	–	mm	–
Gang disc – Relubricatable bearings					
GW208PP17 ¹⁾	1	29,972	Square	85,738	3-lip LS
GW208PPB5	1	29,972	Square	80,000	3-lip LS
GW208PPB8	1	29,972	Square	80,000	3-lip LS
GW210PPB4	1	29,413	Square	90,000	3-lip LS
GW211PP17 ¹⁾	1	38,887	Square	100,000	3-lip LS
GW211PP3-GX ¹⁾	1	38,887	Square	100,000	3-lip LS
GW211PPB3	1	38,887	Square	100,000	3-lip LS
GW212PP50-GX ¹⁾	1	45,466	Square	110,000	3-lip LS
GW214PPB4-GX	1	52,200	Square	125,000	3-lip LS
GW216PP2-GX ¹⁾	1	58,738	Square	140,000	3-lip LS
GW315PPB11-OX	2	70,000	Round	160,000	3-lip LS
GW214PPB6-GX	2	68,278	Round	125,000	3-lip LS
GW214PPB3-OX	2	68,278	Round	125,000	3-lip LS
GW214PPB2-GX	2	70,000	Round	125,000	3-lip LS
GW214PP2-GX ¹⁾	2	70,000	Round	125,000	3-lip LS
GW211PPB9-GX	2	55,753	Round	100,000	3-lip LS
GW211PPB2	2	55,575	Round	100,000	3-lip LS
GW211PPB14	2	51,181	Round	100,000	3-lip LS
GW211PPB13	2	45,339	Round	100,000	3-lip LS
GW211PP53 ¹⁾	2	50,000	Round	100,000	3-lip LS
GW211PP25-GX ¹⁾	2	45,339	Round	100,000	3-lip LS
GW209PPB4-GX	2	38,989	Round	85,000	3-lip LS
GW209PPB22	2	45,000	Round	85,000	3-lip LS
GW209PPB22-BR209RH ²⁾	2	38,989	Round	88,700	3-lip LS
GW211PPB21-BR211RH ²⁾	2	45,339	Round	101,092	3-lip LS

¹⁾ Cylindrical outside diameter

²⁾ Rubber grommets over the outer diameter



Non-relubricatable bearings with square bore
Type 3



Non-relubricatable bearings with round bore
Type 4

Designation	Type	Bore/shaft diameter	Bore type	Outer diameter	Seal type
–		mm	–	mm	–
Gang disc – Non-relubricatable bearings					
W208PP5 ¹⁾	3	29,972	Square	80,0	3-lip LS
W208PP6 ¹⁾	3	26,162	Square	80,0	3-lip LS
W208PP8 ¹⁾	3	29,972	Square	80,0	3-lip LS
W208PPB5	3	29,972	Square	80,0	3-lip LS
W208PPB6	3	26,162	Square	80,0	3-lip LS
W210PP4 ¹⁾	3	29,413	Square	90,0	3-lip LS
W211PP3 ¹⁾	3	38,887	Square	100,0	3-lip LS
W211PP5 ¹⁾	3	38,887	Square	101,6	3-lip LS
W211PPB3	3	38,887	Square	100,0	3-lip LS
W211PPB4	4	55,575	Round	100,0	3-lip LS
W211PPB2	4	55,575	Round	100,0	3-lip LS
W211PP54 ¹⁾	4	52,413	Round	100,0	3-lip LS
W211PP2 ¹⁾	4	55,575	Round	100,0	3-lip LS
W210PPB5	4	45,339	Round	90,0	3-lip LS
W210PPB2	4	49,225	Round	90,0	3-lip LS
W210PP2 ¹⁾	4	49,225	Round	90,0	3-lip LS
W209PPB2	4	45,000	Round	85,0	3-lip LS
W209PPB4	4	38,989	Round	85,0	3-lip LS
W208PPB7	4	30,172	Round	80,0	3-lip LS
W208PPB23	4	38,113	Round	80,0	3-lip LS
W208PP10 ¹⁾	4	38,113	Round	80,0	3-lip LS
W208KPP53	4	38,100	Round	80,0	3-lip LS

¹⁾ Cylindrical outside diameter



Tillage Trunnion Unit (TTU)
Type 1



Tillage Pillowblock Unit (TPU)
Type 2

Designation	Type	Bore/shaft diameter	Housing material	Seal type
–		mm	–	–
Gang disc – Tillage units				
GW211PP25-HDT	1	45,339	Ductile cast Iron	3-lip LS
GW211PP2-HDT	1	55,575	Ductile cast Iron	3-lip LS
W211K56-7L-TTU ¹⁾	1	45,339	Ductile cast Iron	7-lip
W211K58-TTU ¹⁾	1	50,018	Ductile cast Iron	6-lip
W211K59-TTU ²⁾	1	38,887	Ductile cast Iron	6-lip
W214K51-TTU ¹⁾	1	68,278	Ductile cast Iron	6-lip
W214K52-TTU ¹⁾	1	57,912	Ductile cast Iron	6-lip
W214K53-7L-TTU ¹⁾	1	70,000	Ductile cast Iron	7-lip
W214-K54-7L-DTTU-A62 ²⁾	1	50,000	Ductile cast Iron	7-lip
W214-K60-7L-DTTU-HANGER-A515 ¹⁾	1	41,350	Ductile cast Iron	7-lip
W211K57-TPU ¹⁾	2	45,339	Ductile cast Iron	6-lip

¹⁾ Application specific solution

²⁾ Application specific solution with square shaft



Flanged unit with set screw
Type 1



Flanged unit without set screw
Type 2



Flanged unit assembly
Type 3

Designation	Type	Bore/shaft diameter	Housing material	Housing shape	Seal type
–		mm	–	–	–
Seedbed finisher – Flanged unit assembly					
UCF208-40MM-MFTRL ¹⁾	1	40,000	Ductile cast Iron	Squared	5-lip
UCF308-40MM-AP-MF ¹⁾	1	40,000	Ductile cast Iron	Squared	6-lip
XD-UCF208-40MM-XB-AP-TLSL-U435 ¹⁾	1	40,000	Ductile cast Iron	Squared	6-lip
XD-UCF208-40MM-XB-AP-TLSL-U31 ¹⁾	1	40,000	Ductile cast Iron	Squared	5-lip
XD-UCF209-45MM-AP-TLSL-U26 ¹⁾	1	45,000	Ductile cast Iron	Squared	5-lip
UCFS210-50MM-AP-BSLS-U265 ¹⁾	1	50,000	Ductile cast Iron	Squared	6-lip
XD-UCF210-50MM-XB-AP-TLSL-U409 ¹⁾	1	50,000	Ductile cast Iron	Squared	6-lip
XD-UCF210-50MM-XB-AP-TLSL-U117 ¹⁾	1	50,000	Ductile cast Iron	Squared	5-lip
XD-UCFS210-50MM-AP-BSLS-U448 ¹⁾	1	50,000	Ductile cast Iron	Squared	6-lip
UCXF11-32-OX-AP-U131	1	50,800	Ductile cast Iron	Squared	1-lip G
UCXF12-38-OX-AP-U132	1	60,325	Ductile cast Iron	Squared	1-lip G
XD-UCF212-60MM-XB-AP-TLSL-U26 ¹⁾	1	60,000	Ductile cast Iron	Squared	5-lip
XD-UCXF213-65MM-OB-AP-TRL ¹⁾	1	65,000	Ductile cast Iron	Squared	3-lip LS
W212-60MM-MF-DF-A112 ¹⁾	2	60,000	Ductile cast Iron	Squared	6-lip
W210-50MM-MF-R-DF-A490 ¹⁾	2	50,000	Ductile cast Iron	Squared	6-lip
XD-UCFT208-40MM-XB-AP-TLSL-U26 ¹⁾	3	40,000	Ductile cast Iron	Oval	5-lip
XD-UCFT208-40MM-XB-AP-TLSL-NSS-U239 ¹⁾	3	40,000	Ductile cast Iron	Oval	5-lip
XD-UCFT206-30MM-XB-AP-TLSL-U236 ¹⁾	3	30,000	Ductile cast Iron	Oval	5-lip
XD-UCFT206-30MM-XB-AP-TLSL-U469 ¹⁾	3	30,000	Ductile cast Iron	Oval	6-lip
W208-40MM-MF-R-DFT-A374 ¹⁾	3	40,000	Ductile cast Iron	Oval	6-lip
W207-35MM-FTDT-MF-AP ¹⁾	3	35,000	Ductile cast Iron	Oval	6-lip
KX-GRFT206-30MM-AP-TDSL-U429 ²⁾	3	30,000	Ductile cast Iron	Oval	5-lip
XD-UCFC214-70MM-XB-AP-TLSL ¹⁾	3	70,000	Ductile cast Iron	Oval	5-lip

¹⁾ Application specific solution

²⁾ Application specific solution with grip it locking collar



Squared flanged insert bearings
Type 4



Round flanged insert bearing units
Type 5



Pillow block unit
Type 6



Flanged disc
Type 7

Designation	Type	Bore / shaft diameter	Housing material	Housing shape	Seal type
–		mm	–	–	–
Seedbed finisher – Insert bearings					
FY 35 TF	4	35,000	Grey cast Iron	Squared	1-lip F
FY 40 TF	4	40,000	Grey cast Iron	Squared	1-lip F
FY 45 TF	4	45,000	Grey cast Iron	Squared	1-lip F
FY 50 TF	4	50,000	Grey cast Iron	Squared	1-lip F
FY 60 TF	4	60,000	Grey cast Iron	Squared	1-lip F
FY 50 TR	4	50,000	Grey cast Iron	Squared	1-lip RF
FYC 40 TF	5	40,000	Grey cast Iron	Rounded	1-lip F
FYC 50 TF	5	50,000	Grey cast Iron	Rounded	1-lip F
Seedbed finisher – Pillow block unit					
W212-60MM-MF-R-P-A290 ¹⁾	6	60,000	Ductile cast Iron	Pillow	6-lip
Seedbed finisher – Flanged disc					
RFD209K50-1 1/8SQ ¹⁾	7	29,972	Pressed Steel	Rounded	5-lip
RFD209K51-30MMSQ-SP2 ¹⁾	7	30,000	Pressed Steel	Rounded	5-lip
RFD211K51-40MMSQ-A371 ¹⁾	7	40,000	Pressed Steel	Rounded	5-lip

¹⁾ Application specific solution



Flanged disc with round bore,
non-relubricatable
Type 8



Flanged disc with square bore,
non-relubricatable
Type 9



Flanged disc with round bore,
relubricatable
Type 10



Flanged disc with square bore, relubricatable
Type 11



Roller support bearing unit
Type 12

Designation	Type	Bore/shaft diameter	Housing material	Housing shape	Seal type
–		mm	–	–	–
Seedbed finisher – Flanged disc					
FD209K58-1-3/4RD-A326 ¹⁾	8	44,958	Pressed Steel	Squared	5-lip
FD209K50-1-3/4RD ¹⁾	8	49,958	Pressed Steel	Squared	5-lip
FD209K52-1-1/2RD ¹⁾	8	38,989	Pressed Steel	Squared	5-lip
FD209K53-1-1/2RD ¹⁾	8	38,989	Pressed Steel	Squared	6-lip
FD209K54-1-1/4RD ¹⁾	8	32,258	Pressed Steel	Squared	5-lip
FD211K65-1-15/16RDC-A326 ¹⁾	8	49,253	Pressed Steel	Squared	5-lip
FD211K51-1-3/4RD-A366 ¹⁾	8	45,212	Pressed Steel	Squared	5-lip
FD211K52-1-3/4RD-A365 ¹⁾	8	45,212	Pressed Steel	Squared	5-lip
FD211K61-2-3/16RD ¹⁾	8	55,575	Pressed Steel	Squared	5-lip
FD212K51-60RD ¹⁾	8	61,000	Pressed Steel	Squared	5-lip
FD209K51-1-1/4SQ ¹⁾	9	33,020	Pressed Steel	Squared	5-lip
FD209K57-1-1/8SQ-A366 ¹⁾	9	29,972	Pressed Steel	Squared	5-lip
FD211K53-1-1/2SQ ¹⁾	9	38,887	Pressed Steel	Squared	5-lip
FD211-1-3/4RD ¹⁾	10	45,212	Pressed Steel	Squared	3-lip LS
FD211-2-3/16RD ¹⁾	10	55,575	Pressed Steel	Squared	3-lip LS
FD211-1-15/16RDC ¹⁾	10	49,225	Pressed Steel	Squared	3-lip LS
ST491A ¹⁾	10	44,958	Pressed Steel	Squared	3-lip LS
ST491A-B ¹⁾	10	44,958	Pressed Steel	Squared	3-lip LS
ST491B ¹⁾	10	38,989	Pressed Steel	Squared	3-lip LS
FD209-1-1/4SQ ¹⁾	11	33,020	Pressed Steel	Squared	3-lip LS
FD209-1-1/8SQ ¹⁾	11	29,972	Pressed Steel	Squared	3-lip LS
FD211-1-1/2SQ	11	38,887	Pressed Steel	Squared	3-lip LS
Seedbed finisher – Roller support bearing unit					
XD-UCTFU312-39-AP-TLTL-U32 A217 ¹⁾	12	61,912	Ductile Iron	Rounded	6-lip

¹⁾ Application specific solution

Seeding

When the tillage process is complete, it is time for seeding. Seeding opens a narrow furrow in the field for the seed, plants the seeds and then covers them by closing the furrow. These simple steps do though require high precision. Loss of operational precision leads directly to a lower crop yield.

The challenge for the farmer when seeding is to do it quickly but accurately and at the lowest possible cost per hectare. This confirms the importance of selecting the right equipment, which is robust enough to avoid disc wobbling due to high loads, and is properly sealed so as to resist ingress of dirt to achieve a long, reliable service life.

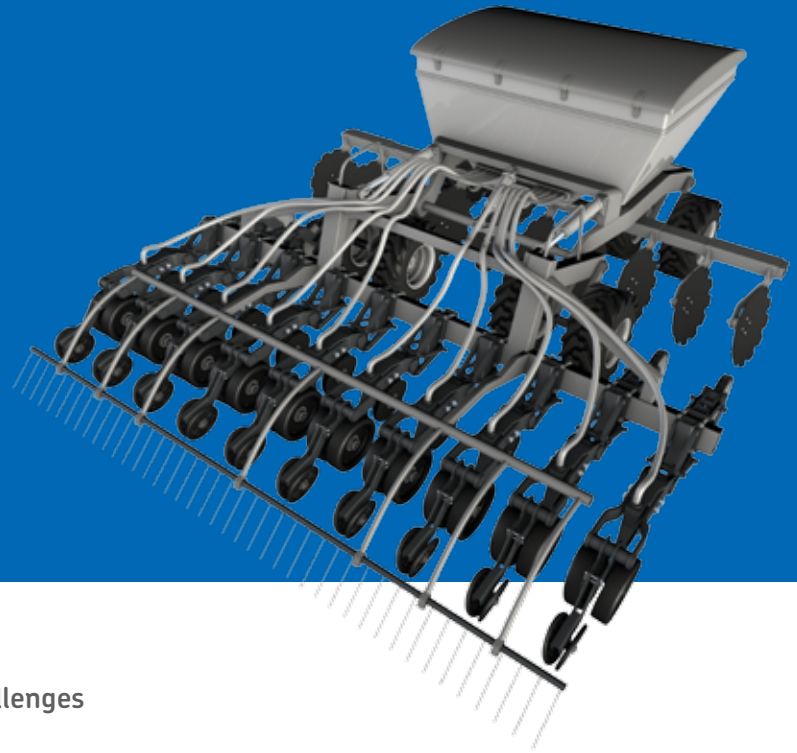

Typical seeding equipment applications

- Opener discs
- Gauge wheels
- Closing discs
- Press wheels, implement wheels, seedmeter drive shafts and row markers

Application challenges

The usage of seeding equipment is very intensive for a limited time and then followed by long periods of inactivity. The intense periods are signified by tough environmental conditions, and sustained work activity. This benefits from the growing conditions prepared during the tillage process. Because of the limited time available for optimal seeding, it is crucial to minimize the downtime during these periods.

Precision is yet again one of the most important factors and is directly connected to and dependent on the reliability of the bearings. The challenge is to maintain precise rotation no matter what the external conditions are.

The consequences of a deficiency in precision or an incorrect seed placement can lead to one or more of the following:

- Insufficient nutrient per seed (if seeds are too close to one another)
- Lower utilization of the field (if seeds are too far from one another)
- Limited aeration and soil resists plant emergence (if seed is too deep)
- Vulnerable to weather, temperature, animals and birds (if seed is too shallow)

The effect can be a reduction in a farmer's yield of up to 60% per season.

Disc opener

Typical conditions for disc opener applications

When opening the furrow, the discs are forced into the soil:

- The bearing assemblies are exposed to mud, dust, crop residues and sometimes stones
- Bearings and discs are subject to high loads

Solutions for disc opener applications

Agri Hubs for seeding are especially designed for seeding applications and opener discs. These are fully integrated units comprising a wide range of flexible designs and are compatible with discs that require external as well as internal mounting. The Agri Hubs for seeding feature a robust five-lip seal which implies that the unit is relubrication-free. Together with steel inserts, this provides good protection of the bearings against solid contaminants such as mud, dust, fibers and water. Through this heavy-duty sealing, the bearing's service life can be increased and at the same time, the need for maintenance and repairs can significantly be reduced.

The integrated bearing is either a four-point contact single or double-row deep groove ball bearing depending on the capacity need. The flexibility of the design also allows to select a hub with a mounting flange made of metal-sheet for additional strength.

Benefits of the SKF Agri Hub

- OEMs
 - Can cut combined warranty, engineering, testing and assembly costs by up to 50%¹⁾
 - Extends bearing unit service life
 - Reduces mounting times and mistakes
 - Differentiates designs
 - Fast delivery worldwide
- End-users
 - Increases bearing unit service life by up to 40%¹⁾
 - Reduces maintenance and ownership costs by up to 20%¹⁾
 - Can be installed or replaced quickly and easily
 - Improves profitability
 - Fast delivery worldwide

Gauge wheel

Typical conditions for gauge wheel applications

- Bearing is assembled in gauge wheel and bolted on machine
- Dusty and sometimes moist environment

Solutions for gauge wheel applications

Benefits and functional features

- Increase productivity and operation life in field due to
 - Optimized internal geometry
 - High load capacity
 - High contamination feature package with exclusive sealing system
- Interchangeable with standard gauge wheel bearings

Press wheel and closing wheel

Typical conditions for press wheel and closing wheel applications

- Press and closing wheel applications perform different functions in the machine but are exposed to similar application conditions; similar bearing solutions are used
- Dusty and sometimes moist environment

Solutions for press wheel and closing wheel applications

Benefits and functional features

- Increase productivity and operation life in field due to
 - Optimized internal geometry
 - High load capacity
 - High contamination feature package with exclusive sealing system

¹⁾ All figures and graphs are rounded off and based on SKF testing against conventional bearings. Savings and results will vary in specific applications.



Agri Hub S10
Type 1



Agri Hub S20
Type 2



Agri Hub S80/S100
Type 3



Agri Hub S100
Type 4



Agri Hub S100
Type 5

Designation	Type	Bore/shaft diameter	Housing material	Bolt pitch diameter	Holes	Seal type	Performance	Disc diameter
–		mm	–	mm	–	–	–	mm
Disc opener – Agri Hubs								
AGHU2075X6H-LC1L ¹⁾	2	16,000	Steel	75,0	–	3-lip LS	S20	up to 350
AGHU2075X6F-1LLC ¹⁾	2	16,000	Steel	75,0	–	3-lip LS	S20	up to 350
HUB-16MM-X ¹⁾	3	16,000	Steel	60,0	–	6-lip	S100	up to 350
BB2204-PY3-R_ZDFC-A481 ¹⁾	1	16,053	Steel	60,0	–	1-lip	S10	up to 350
AGHU1660X6E-2L-VF01 ¹⁾	1	20,000	Steel	60,0	–	2-lip	S10	up to 350
BB204-KPP58-R-FC-A480 ¹⁾	3	20,000	Steel	79,4	–	3-lip LS	S80	up to 350
BB204-KPP58-R-FC-A481 ¹⁾	3	20,000	Steel	79,4	–	3-lip LS	S80	up to 350
AGHU2075X6H-1LLC ¹⁾	2	20,000	Steel	75,0	–	3-lip LS	S20	up to 350
AGHU1675X6H-1LLC ¹⁾	2	20,000	Steel	75,0	–	3-lip LS	S20	up to 350
AGHU1675X6H-LC1L ¹⁾	2	20,000	Steel	75,0	–	3-lip LS	S20	up to 350
HUB-20MM-X ¹⁾	4	20,000	Steel	80,0	–	6-lip	S100	up to 350
HUB-20MM-X-ASSY-A543 ¹⁾	4	20,000	Steel	80,0	5	6-lip	S100	up to 350
HUB-20MM-X-ASSY-A546 ¹⁾	4	20,000	Steel	80,0	6	6-lip	S100	up to 350
HUB-20MM-X-ASSY-A553 ¹⁾	4	20,000	Steel	80,0	6	6-lip	S100	up to 350
HUB-20MM-X-ASSY-A580 ¹⁾	4	20,000	Steel	80,0	5	6-lip	S100	up to 350
HUB-20MM-X-ASSY-A605 ¹⁾	4	20,000	Steel	75,0	5	6-lip	S100	up to 350
HUB-20MM-X-ASSY-A613 ¹⁾	4	20,000	Steel	80,0	6	6-lip	S100	up to 350
KIT-HUB-20MM-X-ASSY-A157 ¹⁾	4	20,000	Steel	80,0	5	6-lip	S100	up to 350
HUB-20MM-ASSY-A671 ¹⁾	4	20,000	Steel	127,0	5	6-lip	S100	up to 350
BB204-KPMF59-R-FC-A481 ¹⁾	4	20,000	Steel	79,4	4	6-lip	S100	up to 350
AGHU2080X6F-MBMB ¹⁾	5	20,000	Steel	80,0	–	MS	S100	up to 350

¹⁾ Application specific solution



Angular contact ball bearing
Type 1



Special bearing
Type 2



Special bearing
Type 3

Designation	Type	Bore / shaft diameter	Bore type	Seal type
–		mm	–	–
Disc Opener – Angular contact ball bearings				
3204 CETN9	1	20	Round	1-lip RS1
3204 CE-2RSH1TN9	1	20	Round	1-lip RS1
3204 CE-2RS1TN9	1	20	Round	1-lip RS1
3304 CETN9	1	20	Round	1-lip RS1
3304 CE-2RSH1TN9	1	20	Round	1-lip RS1
3304 CE-2RS1TN9	1	20	Round	1-lip RS1
Disc opener – Special bearings				
5203-KPP2-R-A574 ¹⁾	2	16,256	Round	3-lip LS
5204-KPP55-R-A248 ¹⁾	2	16,250	Round	3-lip LS
5204KRP51 ¹⁾	2	16,129	Round	3-lip LS
5204-KRMF-R-A517 ¹⁾	2	16,100	Round	4-lip
5204-2RS ¹⁾	2	20,000	Round	3-lip LS
W5204-2RSTFP-C3-TN ¹⁾	2	20,000	Round	1-lip F
5204-KP52-R-A116 ¹⁾	2	20,000	Round	3-lip LS
5204KP52-SP6 ¹⁾	2	20,000	Round	3-lip LS
5206KPP3 ¹⁾	2	30,150	Round	3-lip LS
BB203KRR5 ¹⁾	3	13,061	Round	1-lip
203NPP9 ¹⁾	3	15,900	Round	1-lip R
204PY3 ¹⁾	3	16,053	Round	2-lip
203KRR2FD ¹⁾	3	16,256	Round	2-lip
BB203KYY2 ¹⁾	3	16,256	Round	1-lip
BB304PP50 ¹⁾	3	16,129	Round	3-lip LS
BB204-PF3-R-A453 ¹⁾	3	16,053	Round	3-lip LS
205KRP2 ¹⁾	3	19,202	Round	3-lip LS
BB205KRP2 ¹⁾	3	19,202	Round	3-lip LS
205-KRP5-R-A17 ¹⁾	3	20,000	Round	3-lip LS
206KRP4 ¹⁾	3	25,146	Round	3-lip LS
206-KRP50-R-A422 ¹⁾	3	30,000	Round	3-lip LS

¹⁾ Application specific solution



Special bearing
Type 3



Special bearing
Type 4



Special bearing
Type 5

Designation	Type	Bore /shaft diameter	Bore type	Seal type
–		mm	–	–
Gauge wheel – Special bearings				
5203KYY50	4	15,650	Round	2-lip
5203KPP2	4	16,256	Round	3-lip LS
5203KYY2	4	16,256	Round	2-lip
5203-KRR2-R-A230	4	16,256	Round	1-lip G
5203-KMF-R-A120	4	16,256	Round	6-lip
5203-ZZ	4	17,000	Round	Z Shield
WP5203-KRP2-N-A217	5	15,660	–	3-lip LS
Press wheel/Closing wheel – Special bearings				
BB203KRR5 ¹⁾	3	13,061	Round	1-lip
203NPP9 ¹⁾	3	15,900	Round	1-lip R
BB203KYY2 ¹⁾	3	16,256	Round	1-lip
5203KYY2	4	16,256	Round	2-lip

¹⁾ Application specific solution



Special bearing
Type 3



Special unit
Type 6



Special unit
Type 7



Flanged disc
Type 8



Special bearing
Type 9

Designation	Type	Bore/shaft diameter	Bore type	Seal type
–		mm	–	–
Seedmeter – Special bearings and units				
5203KYY50-ASSY ¹⁾	7	15,850	–	2-lip
Seedmeter drive shaft – Special bearings and units				
205KRRB2	3	22,250	Hexagonal	1-lip G
205KPP2 ¹⁾	3	22,250	Hexagonal	3-lip LS
205KPPB54	3	22,250	Hexagonal	3-lip LS
2BF205-7/8HX	6	22,250	Hexagonal	3-lip LS
Z206-KRR52-H-A415 ¹⁾	9	22,700	Hexagonal	1-lip G
FHPFL208-40MM-AP	8	40,000	Round	1-lip F

¹⁾ Cylindrical outside diameter

Harvesting

Harvest season is hard, and a machinery breakdown at this crucial time can endanger a full season of hard work. Combine harvesters are amongst the most complex of farming machines; reliant on many sub-systems to achieve the harvesting, threshing and winnowing of the crop and final unloading of the grain.



Combine harvester

Application challenges

After sitting idle for months, harvesters are put through grueling, round-the-clock schedules. If crop debris, dirt and water work their way into critical components, their service life is substantially reduced.

Challenges include:

- Crop particle and other solid contaminant ingress
- Wash-downs
- Task time criticality, machine availability

If the bearings and seals are not designed for these kinds of conditions, it can easily lead to damage and early life failure. Such events can lower productivity, significantly increase maintenance costs and reduce overall profitability.

Typical conditions for combine harvester applications

- Operates with constant exposure to heavy dust and crop contact
- Subject to static misalignment due to imprecise mounting surfaces

Solutions for combine harvester applications

Among the many products especially developed to handle harsh conditions, SKF offers insert bearing units (relubrication-free, quick and easy to mount), a range of radial ball and roller bearings, seals and lubrication systems. For applications where the contamination risk is high, SKF agricultural insert bearing units with their relubrication-free design and increased service life can help to:

- Reduce maintenance and ownership costs
- Keep grease from contaminating the grain

SKF insert bearing units incorporate high performance sealing solutions that have been tested and proven under farm conditions. Appropriate to the precise application, the insert bearing range includes bearings as well as bearings and housings. Both are available with seals optimized for the application and the contamination level in that specific environment. The unitized nature of these designs means fewer separate components, allowing a plug and play approach for quick and easy mounting.

SKF has also developed a specific range of deep groove ball bearings for positions with limited space not allowing an SKF Y-bearing assembly or for higher rotating speeds with tight press-fit on shaft and/or housing. They feature a high performance sealing and specific grease for harsh agricultural conditions. This range is identified with an AAG-VA387 suffix (e.g. 6206-2RS1/AAG-VA387).



Disc mower

As disc mowers cut and prepare hay for drying, unplanned stops for maintenance or repairs means lost production. Too often, conventional bearing and sealing arrangements enable such losses by allowing gear particles or other contaminants to enter the bearings. Lubricant loss, bearing failures and costly breakdowns can follow, causing risks to operator safety and the bottom line.

Solutions for disc mower applications

Designed to be more productive and easier to maintain, robust seal designs and relubrication-free bearing units from SKF can help prevent unplanned downtime. SKF harrow units have been tested to withstand heavy vibration and harsh field conditions. Integrated and compact, they also help OEMs reduce components and speed up assembly.



Baling

The process of converting windrows of crop into bales, necessitates the pickup of crop, compacting and wrapping inside the bale chamber and ejection of the completed bale. Much of this processing relies on rollers and for a square baler, a reciprocating plunger, so multiple bearings are required to produce an effective as well as a precise baling process.

Application challenges

Baling can impose heavy loads on the machine components, which is why it is essential that the bearings can sustain these stresses. It is also of great importance that at the same time, the bearings can exclude dust and crop wrap to minimize the time required for maintenance and service.

- Many bearings exposed to heavy loads
- Dust and crop wrap
- Improving precision, and bale quality
- Increasing productivity

If the support bearings are not designed for these kinds of conditions, it can easily lead to damage and early life failure. Such events can lower productivity, increase maintenance costs and reduce overall profitability.

Typical conditions for baler applications

Operates with exposure to crop wrap and dust, in dry hay conditions and with higher moisture conditions when baling silage.

Solutions for baler applications

Among the many products especially developed to handle harsh conditions, SKF offers its insert bearings (relubrication-free, quick and easy to mount), a range of radial ball and roller bearings, and seals. For applications where the contamination risk is high, SKF agricultural insert bearing units with their relubrication-free design and increased service life can help to:

- Reduce maintenance and ownership costs
- Keep grease from contaminating crops, soil, or groundwater supplies

Typical conditions for pick-up assembly applications

The pick-up assembly rakes the hay from the windrow into the baling chamber. Tine bar, pickup drum and cam follower are all part of the pickup subassembly.

- The tine bar rakes the hay off the field into the baling chamber
- The cam follower creates a flipping action to the tine bar to deposit the hay into the baling chamber
- The pick-up drum rotates and supports multiple tine bars creating a raking action

Solutions for pick-up assembly applications

Bearings for pick-up applications are designed for impact and long wear life in the case of cam followers and robust seals for tine bar and pick-up drum positions.



Double row angular contact ball bearing
Type 1



Special Bearing
Type 2



Special bearing
Type 3



Deep groove ball bearing
Type 4



Insert bearing
Type 5



Mounted unit
Type 8

Designation	Type	Bore / shaft diameter	Bore type	Outer diameter	Seal type
–		mm	–	mm	–
Head – Double row angular contact ball bearing (DRACBB)					
3201 ATN9 ¹⁾	1	12,000	Round	32	–
3204 CE-2RS1TN9/C3 ¹⁾	1	20,000	Round	47	1-lip RS1
3214 A ¹⁾	1	70,000	Round	125	–
Head – Insert and special bearings					
203KPP50 ¹⁾	2	16,256	Round	40	3-lip LS
204KRR2 ¹⁾	3	17,653	Hexagonal	47	1-lip G
FH206-18-AP	5	28,575	Round	62	1-lip F
207KRRB9	3	28,600	Hexagonal	72	1-lip G
207KPPB57	3	31,775	Hexagonal	72	3-lip LS
Head – Deep groove ball bearing (DGBB)					
6304-2RSH ¹⁾	4	20,000	Round	52	1-lip RSH
6015-2RS1 ¹⁾	4	75,000	Round	115	1-lip RS1
Head – Mounted unit					
207-KPPB57-H-FT-A17 ²⁾	8	31,775	Oval	130,2	3-lip LS

¹⁾ Cylindrical outside diameter
²⁾ Hexagonal bore



Special bearing
Type 3



Insert bearing
Type 5



Sealed spherical roller bearing
Type 6



Spherical roller bearing
Type 7

Designation	Type	Bore/shaft diameter	Bore type	Outer diameter	Seal type
–		mm	–	mm	–
Feederhouse/Rotor – Spherical roller bearings					
BS2-2206-2RS/VT143 ¹⁾	6	30,000	Round	62	1-lip RS1
BS2-2207-RS/VT143 ¹⁾	6	35,000	Round	72	1-lip RS1
22208 E ¹⁾	7	40,000	Round	80	–
BS2-2208-2RS/VT143 ¹⁾	6	40,000	Round	80	1-lip RS1
BS2-2208-2RSW/GEM9 ¹⁾	6	40,000	Round	80	2RSW ²⁾
BS2-2212-2RS/VT143 ¹⁾	6	60,000	Round	110	1-lip RS1
Feederhouse/Rotor – Insert and special bearings					
W208PPB16	3	31,780	Hexagonal	80	3-lip LS
209KRRB2	3	38,100	Hexagonal	85	1-lip G
FH208-40MM-AP	5	40,000	Round	80	1-lip F
W211KRRB50	3	44,475	Hexagonal	100	1-lip G

¹⁾ Cylindrical outside diameter

²⁾ Two seals and no W33 groove – W no lubrication holes in outer ring



Special Bearing
Type 2



Special bearing
Type 3



Insert bearing
Type 5

Designation	Type	Bore/shaft diameter	Bore type	Outer diameter	Seal type
–		mm	–	mm	–

Clean Grain/Residue – Insert and special bearings

204KRR2 ¹⁾	3	17,653	Hexagonal	47	1-lip G
FH205-14-AP	5	22,225	Round	52	1-lip F
205KPPB2	3	22,250	Hexagonal	52	3-lip LS
FH205-25MM-AP	5	25,000	Round	52	1-lip F
HC205-25MM-AP	5	25,000	Round	52	1-lip G
UC205-25MM-AP	6	25,000	Round	52	1-lip G
YELAG 205	5	25,000	Round	52	3-lip HS
YARAG 205	6	25,000	Round	52	3-lip HS
FH205-16-AP	5	25,400	Round	52	1-lip F
HC205-16-AP	5	25,400	Round	52	1-lip G
YELAG 205-100	5	25,400	Round	52	3-lip HS
206KRR6 ¹⁾	3	25,425	Hexagonal	62	1-lip R
FH206-18-AP	5	28,575	Round	62	1-lip F
YELAG 206-102	5	28,575	Round	62	3-lip HS
208KPPB52	3	28,600	Hexagonal	80	3-lip LS
FH206-30MM-AP	5	30,000	Round	62	1-lip F
HC206-30MM-AP	5	30,000	Round	62	1-lip G
UC206-30MM-AP	6	30,000	Round	62	1-lip G
YELAG 206	5	30,000	Round	62	3-lip HS
YARAG 206	6	30,000	Round	62	3-lip HS
FH206-19-AP	5	30,162	Round	62	1-lip F
HC206-19-AP	5	30,162	Round	62	1-lip G
YELAG 206-103	5	30,162	Round	62	3-lip HS
FH206-20-AP	5	31,750	Round	62	1-lip F
FH207-20-AP	5	31,750	Round	72	1-lip F
HC206-20-AP	5	31,750	Round	62	1-lip G
HC207-20-AP	5	31,750	Round	72	1-lip G
YELAG 207-104	5	31,750	Round	72	3-lip HS
FH207-22-AP	5	34,925	Round	72	1-lip F
FHR207-22-AP-SP2 ¹⁾	5	34,925	Round	72	1-lip F
HC207-22-AP	5	34,925	Round	72	1-lip G
YELAG 207-106	5	34,925	Round	72	3-lip HS
FH207-35MM-AP	5	35,000	Round	72	1-lip F
HC207-35MM-AP	5	35,000	Round	72	1-lip G
UC207-35MM-AP	6	35,000	Round	72	1-lip G
207KRR3 ¹⁾	2	35,000	Round	72	1-lip G
YELAG 207	5	35,000	Round	72	3-lip HS
YARAG 207	6	35,000	Round	72	3-lip HS
FH207-23-AP	5	36,512	Round	72	1-lip F
YELAG 207-107	5	36,512	Round	72	3-lip HS
HC207-23-AP	5	36,513	Round	72	1-lip G



Insert bearing
Type 6

Designation	Type	Bore/shaft diameter	Bore type	Outer diameter	Seal type
–		mm	–	mm	–
Clean Grain/Residue – Insert bearings					
FH208-24-AP	5	38,100	Round	80	1-lip F
HC208-24-AP	5	38,100	Round	80	1-lip G
YELAG 208-108	5	38,100	Round	80	3-lip HS
FH208-40MM-AP	5	40,000	Round	80	1-lip F
HC208-40MM-AP	5	40,000	Round	80	1-lip G
UC208-40MM-AP	6	40,000	Round	80	1-lip G
YELAG 208	5	40,000	Round	80	3-lip HS
YARAG 208	6	40,000	Round	80	3-lip HS
HC209-26-AP	5	41,275	Round	85	1-lip G
YELAG 209-111	5	42,862	Round	85	3-lip HS
FH209-28-AP	5	44,450	Round	85	1-lip F
HC209-28-AP	5	44,450	Round	85	1-lip G
YELAG 209-112	5	44,450	Round	85	3-lip HS
FH209-45MM-AP	5	45,000	Round	85	1-lip F
HC209-45MM-AP	5	45,000	Round	85	1-lip G
UC209-45MM-AP	6	45,000	Round	85	1-lip G
YELAG 209	5	45,000	Round	85	3-lip HS
YARAG 209	6	45,000	Round	85	3-lip HS

¹⁾ Cylindrical outside diameter



Deep groove ball bearing
Type 4



Sealed spherical roller bearing
Type 6



Spherical roller bearing
Type 7

Designation	Type	Bore/shaft diameter	Bore type	Outer diameter	Seal type
–		mm	–	mm	–
Clean Grain/Residue – Spherical roller bearings					
BS2-2210-2RS/VT143 ¹⁾	6	50,000	Round	90	1-lip RS1
22211 E ¹⁾	7	55,000	Round	100	–
22213 E/C3 ¹⁾	7	65,000	Round	120	–
Clean Grain/Residue – Deep groove ball bearing					
6012-2RS1 ¹⁾	4	60,000	Round	95	1-lip RS1
6218-2RS1 ¹⁾	4	90,000	Round	160	1-lip RS1
6020-2RS1 ¹⁾	4	100,000	Round	150	1-lip RS1

¹⁾ Cylindrical outside diameter



Mounted unit
Type 1



Mounted unit
Type 3

Designation	Type	Bore/shaft diameter	Housing material	Number of holes	Housing shape	Bolt spacing	Seal type
–		mm	–	–	–	–	–
Clean Grain/Residue – Mounted units							
FYTBK 20 WD	1	20,000	Composite	2	Oval	90,0	3-lip HS
FYTBK 25 WD	1	25,000	Composite	2	Oval	99,0	3-lip HS
FYTBK 30 WD	1	30,000	Composite	2	Oval	116,5	3-lip HS
FY 2.7/16 TF	3	61,913	Grey cast iron	4	Square	143,0	1-lip 2F



Deep groove ball bearing
Type 1



Special bearing
Type 2



Agri Hub M100
Type 3

Designation	Type	Bore/shaft diameter	Bore type	Outer diameter	Seal type
–		mm	–	mm	–
Gear Drive – Deep groove ball bearing (DGBBB)					
6207 2RS1	1	35	Round	72,000	1-lip RS1
6307 2RS1	1	35	Round	80,000	1-lip RS1
6207 2RSH	1	35	Round	72,000	1-lip RSH
6307 2RSH	1	35	Round	80,000	1-lip RSH
Gear Drive – Special bearing					
6209-ZZU-NR-NR-TN-C3-V2-L151-FE-R159	2	45	Round	85,000	ZZ Double shield
Shaft Drive – Agri Hub					
BAH-0013 E	3	35	Round	72,043	CS ¹⁾
BAH-0013 D	3	35	Round	72,043	CS
BAH-0013 AB	3	35	Round	72,043	CS ²⁾

¹⁾ Low friction seal
²⁾ Oil seal



Special bearing
Type 1



Special bearing
Type 2



Special bearing
Type 3



Special bearing
Type 4



Special bearing
Type 5



Agri Hub M100
Type 6

Designation	Type	Bore/shaft diameter	Bore type	Outer diameter	Seal type
–	–	mm	–	mm	–
Pick-up – Special bearing					
CF5002-ASSY	1	12,700	Integral bolt	38,1	2-lip
CF5202-2RST-8	2	12,700	Round	38,1	2-lip
FHRL6005-BB9105 ¹⁾	3	27,280	Round	47,0	1-lip R
FHRL6005-BB9105-EE-SP1 ²⁾	4	27,280	Round	47,0	1-lip R
207KRRB12	5	28,600	Hexagonal	72,0	1-lip G
207KRRB17	5	31,775	Hexagonal	72,0	1-lip G
Pick-up – Agri Hub					
BAH-0069	6	42,000	Round	78,0	CS

¹⁾ Narrow version
²⁾ Wide version



Mounted unit
Type 1



Special mounted unit
Type 2



Special mounted unit
Type 3



Mounted unit
Type 4



Flanged unit assembly
Type 5

Designation	Type	Bore / shaft diameter	Housing material	Number of holes	Housing shape	Bolt spacing	Seal type
–		mm	–	–	–	mm	–

Round baler – Mounted units

HCF3X206-30MM-TRL-AP	1	30,000	Ductile Cast	3	Triangle	90,5	3-lip LS
GW208-KPPB50-H-OX-DF4X-A226 ¹⁾	2	31,775	Ductile Cast	4	Square	119,1	3-lip LS
HCFTS208-40MM-AP	5	40,000	Grey Cast Iron	2	Oval	143,6	1-lip G
GW210-KPPB50-H-OX-DF4X-A237 ¹⁾	2	44,475	Ductile Cast	4	Square	127,0	3-lip LS
GW211-KPPB51-H-OB-FS-A222 ²⁾	3	44,475	Grey Cast Iron	4	Square	130,2	3-lip LS
HCFS209-45MM-AP	4	45,000	Grey Cast Iron	4	Square	104,9	1-lip G
HCFS310-50MM-AP	4	50,000	Grey Cast Iron	4	Square	130,2	1-lip G

¹⁾ Hexagonal bore, bolt spacing is diameter of bolt circle

²⁾ Hexagonal bore

Special bearing
Type 7Special bearing
Type 8Insert bearing
Type 9Special bearing
Type 10Deep groove ball bearing
Type 11Insert bearing
Type 12

Designation	Type	Bore/shaft diameter	Bore type	Outer diameter	Seal type
–		mm	–	mm	–
Round baler – Insert and special bearings					
207KPPB55	8	31,775	Hexagonal	72	3-lip LS
W208PP21 ¹⁾	7	31,775	Hexagonal	80	3-lip LS
W208KRRB6	8	34,950	Hexagonal	80	1-lip G
CF6007PP51-SP1	10	35,000	Round	72	3-lip LS
FHR208-24-AP ¹⁾	12	38,100	Round	80	1-lip F
UCR208-24-AP-TRL-M164	9	38,100	Round	80	1-lip G
W208KPP53 ¹⁾	10	38,100	Round	80	3-lip LS
W215KPP52 ¹⁾	7	38,250	Hexagonal	130	3-lip LS
208KRR4 ¹⁾	10	38,892	Round	80	1-lip G
W312KPP51 ¹⁾	7	44,602	Hexagonal	130	3-lip LS
UCR212-39-AP-TRL-M170	9	61,912	Round	110	3-lip LS
Round baler – Deep groove ball bearing (DGBB)					
6307-2RS1 ¹⁾	11	35,000	Round	80	1-lip RS1
6211-2RS1/C3 ¹⁾	11	55,000	Round	100	1-lip RS1

¹⁾ Cylindrical outside diameter



Special bearing
Type 10



Special bearing
Type 12



Special bearing
Type 13



Hub bearing unit (HBU1T)
Type 14



Spherical roller bearing
Type 15

Designation	Type	Bore/shaft diameter	Bore type	Outer diameter	Seal type
–		mm	–	mm	–
Square baler – Special bearing					
TG1603RRR50-A	12	6,477	Round	31,75	1-lip G
BBY-0076	12	6,350	Round	31,50	2-lip
BBY-0083	12	6,350	Round	31,50	2-lip
203KRR3	10	15,951	Round	50,80	1-lip F
6901PK-ASSY-A539	13	19,050	Integral bolt (long)	63,50	2-lip
6901PK-ASSY-A557	13	19,050	Integral bolt (short)	63,50	2-lip
205KYY3	10	19,202	Round	63,50	2-lip
Square baler – Hub bearing unit tapered first generation (HBU1T)					
BTHB-1866046AC-Q	14	41,000	Round	68,00	CS
Square baler – Spherical roller bearing (SRB)					
22213 E	15	65,000	Round	120,00	–
23220 CC/W33	15	100,000	Round	180,00	–



Attachments and trailer wheels

Implement wheel and walking beam of tillage and seeding machines

Aside from the tillage or seeding discs themselves, multiple bearings are used to mount implement wheels and to provide walking beam support structures.

Application challenges

Implements and attachments come in a variety of shapes and sizes, but what they have in common is that the associated bearings must tolerate harsh working environments. Some of the challenges faced include:

- Combined radial and axial loads
- Shock loading
- Higher machine speeds (for higher productivity)

If the bearings and seals are not designed for these kinds of conditions, it can easily lead to damage and early life failure. Such events lower productivity, significantly increase maintenance costs and reduce overall profitability.

Solutions for attachments and trailer wheels

For implement wheel and walking beam support, SKF offers a range of single row tapered roller bearings. In these applications, the bearings are used in opposing pairs and are designed to accommodate combined loads (simultaneous radial and axial).



Designation	Bore/shaft diameter	Bore type	Outer diameter	Total width
–	mm	–	mm	–

Implement wheel and walking beam – Tapered roller bearings

JLM 104948 AA/ JLM 104910 AA	50,000	Round	82,000	21,500
LM 102949/ LM 102910	45,242	Round	73,431	19,558
LM 11949/ LM 11910	19,050	Round	45,237	15,494
LM 12749/ LM 12710	22,000	Round	45,237	15,494
LM 29749/ LM 29710	38,100	Round	65,088	18,034
LM 48548/ LM 48510	34,925	Round	65,088	18,034
LM 501349/ LM 50310	41,275	Round	73,431	19,558
LM 503349/ LM 503310	46,000	Round	75,000	18,000
LM 67048/ LM 67010	31,750	Round	59,131	15,875
LM 48548/ LM 48510	34,925	Round	65,088	18,034
460/ 453A	44,450	Round	107,950	27,783
2790/ 2720	33,338	Round	76,200	23,774
3780/ 3720	50,800	Round	93,264	30,162
15123/ 15250	31,750	Round	63,500	19,478
15126/ 15250	31,750	Round	63,500	20,638
25580/ 25520	44,450	Round	82,931	23,812
25590/ 25520	45,618	Round	82,931	23,812
25877/ 25821	34,925	Round	73,025	23,812
30207	35,000	Round	72,000	18,250
33109	45,000	Round	80,000	26,000
33889/ 33821	50,800	Round	95,250	27,783
39585/ 39520	63,500	Round	112,712	30,162
45289/ 45220	57,150	Round	104,775	30,162
342A-d2/ 332	41,275	Round	80,000	28,575
387AS/ 382A	57,150	Round	96,838	21,000
HM212049/ HM212011	66,675	Round	122,238	38,100
HM218248/ HM218210	89,974	Round	146,975	40,000
HM803149/ HM803110	44,450	Round	88,900	30,162
JL69349/ JL69310	38,000	Round	62,000	17,000
JLM506849/ JLM506810	55,000	Round	90,000	23,000
L44643/ L44610	25,400	Round	50,292	14,224
L44649/ L44610	26,988	Round	50,292	14,224
L68149/ L68111	34,988	Round	59,975	15,875
LM104949/ LM104911	50,800	Round	82,550	21,590
LM29749/ LM29710	38,100	Round	65,088	18,034
LM48548/ LM48510	34,925	Round	65,088	18,034
LM501349/ LM501310	41,275	Round	73,431	19,558
LM603049/ LM603011	45,242	Round	77,788	19,842
LM67048/ LM67010	31,750	Round	59,131	15,875



skf.com | peerbearing.com

© SKF, SKF EXPLORER and PEER are registered trademarks of the SKF Group.

© SKF Group 2019

The contents of this publication are the copyright of the publisher and may not be reproduced (even extracts) unless prior written permission is granted. Every care has been taken to ensure the accuracy of the information contained in this publication but no liability can be accepted for any loss or damage whether direct, indirect or consequential arising out of the use of the information contained herein.

PUB 46/P1 18686 EN · October 2019

This publication supersedes publication PUB 46/P2 17659 EN and PUB 46/P1 18096 EN.

Certain image(s) used under license from Shutterstock.com.